



B R A
M O L
D E •

PAINÉIS PARA PORTAS

PANELES PARA PUERTAS

PANNEAUX POUR PORTES

PANELS FOR DOORS

2020
ED. 1

Os puxadores não fazem parte dos painéis, são meramente exemplificativos
Las manillas no hacen parte de los paneles, sirven sencillamente de ejemplo
Les poignées ne font pas partie des panneaux, ils sont uniquement à titre d'illustration
The handles are not part of the panels, they are for illustration purposes only

Janeiro 2020 – Esta edição anula as anteriores
Enero 2020 – Esta edición anula las anteriores
Janvier 2020 – Cette édition annule las précédentes
January 2020 – This edition overrides the previous ones

Índice

PAINÉIS RETILINE PANELES RETILINE / PANNEAUX RETILINE / PANELS RETILINE	4
PAINÉIS LINEFASHION PANELES LINEFASHION / PANNEAUX LINEFASHION / PANELS LINEFASHION	34
PAINÉIS NEWLINE PANELES NEWLINE / PANNEAUX NEWLINE / PANELS NEWLINE	68
PAINÉIS ARO OCULTO PANELES ARO OCULTO / PANNEAUX OUVRANT CACHÉ / PANELS HIDDEN FRAME	103
INJEÇÃO DE POLIURETANO INYECCIÓN DE POLIURETANO / INJECTION DE POLYURÉTHANE / POLYURETHANE INJECTION	108
PROJETO PROYECTO / PROJET / PROJECT	110
ACABAMENTOS ACABADOS / FINITION / FINISHES	112
CARACTERÍSTICAS TÉCNICAS DATOS TÉCNICOS / CARACTÉRISTIQUES TECHNIQUES / TECHNICAL DATA	114
PUXADORES TIRADORES / POIGNÉES / PULL HANDLES	116
VIDROS E VITRAIS VITRALES / VERRES / GLASSES	117
ALMOFADAS ALMOFADAS	118
GARANTIA GARANTÍA / GARANTIE / WARRANTY	121

PAINÉIS RETILINE

PANELES RETILINE // PANNEAUX RETILINE
RETILINE PANELS.



23

LR 14 i



24

LR 15 i



25

LR 16 i



26

LR 17 i



27

LR 18 i



30

LR 19 i



31

LR 20 i



32

LR 21 i



Painéis LR
Estampados

Paneles LR
Estampados

Panneaux LR
Emboutis

Panelis LR
Pressed





LR 1

Panel Retline



LR 1 i

Panel Retline

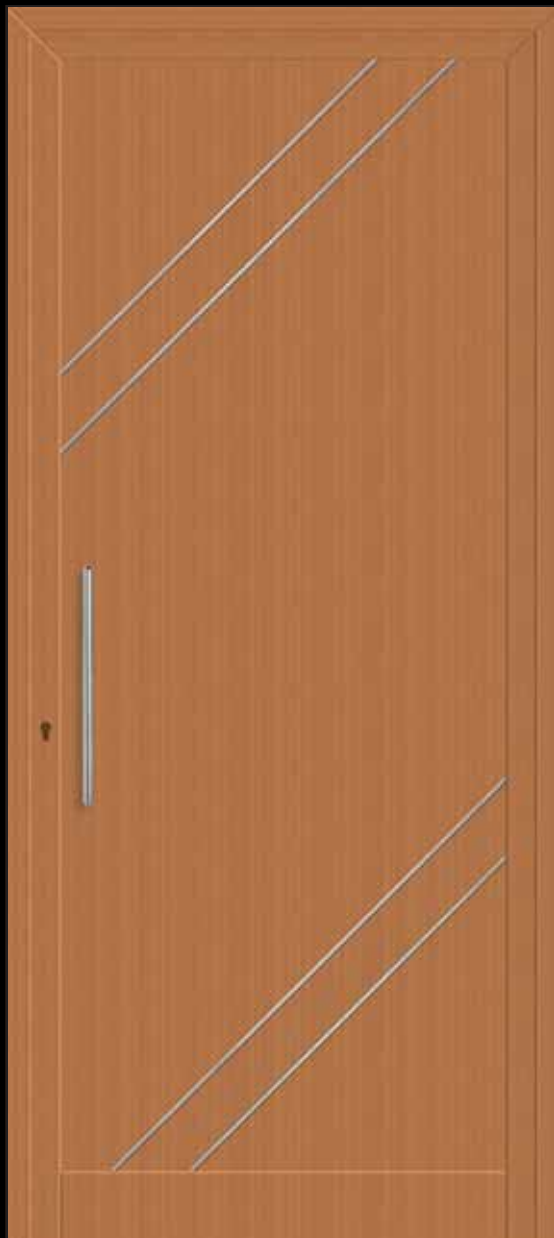



LR 2
Panel Retline

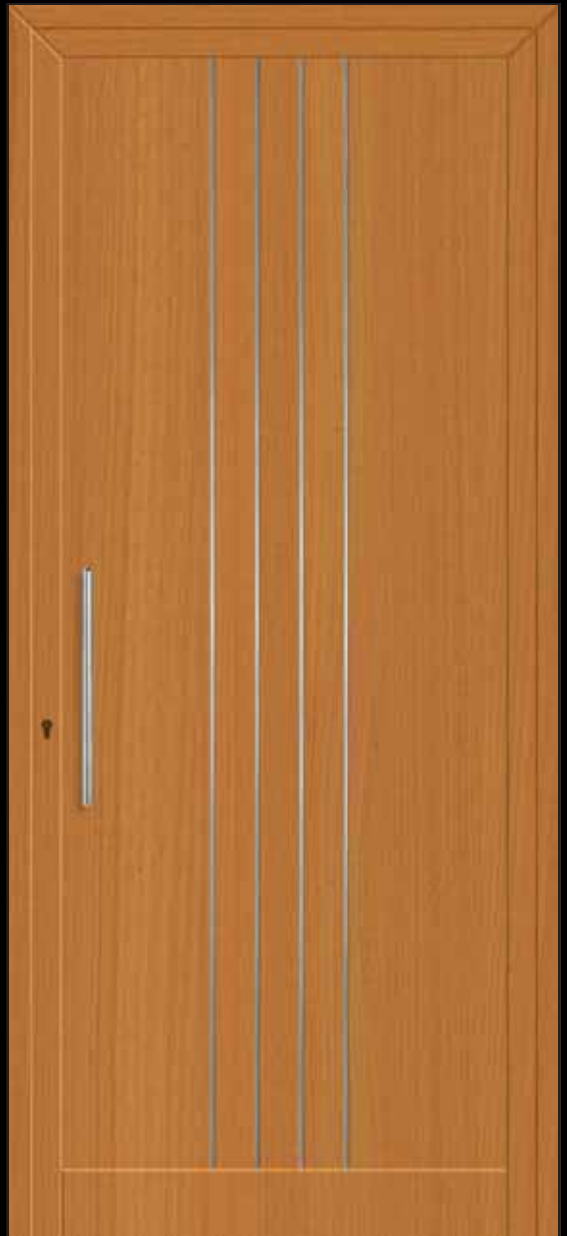

LR 2 Ā
Panel Retline



LR 3
Panel Restline



LR 3 ĩ
Panel Restline



LR 4

Panel Retline



LR 4 ĩ

Panel Retline

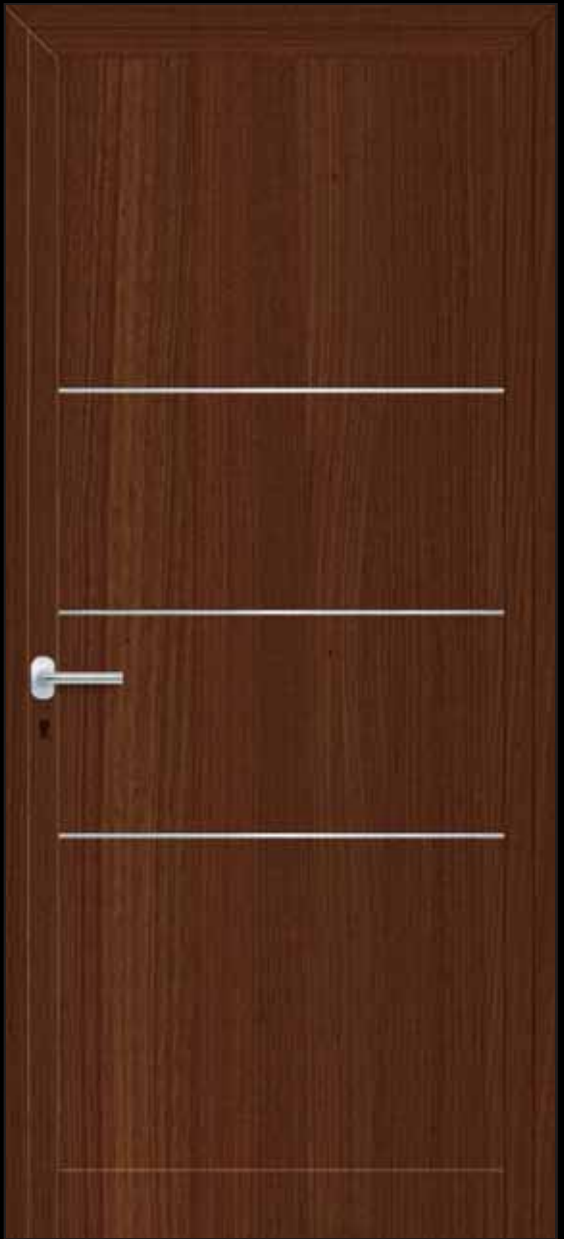



LR 5
Patmel Restline



LR 5 Ā
Patmel Restline



LR 6

Paanel Retilne



LR 6 ĩ

Paanel Retilne

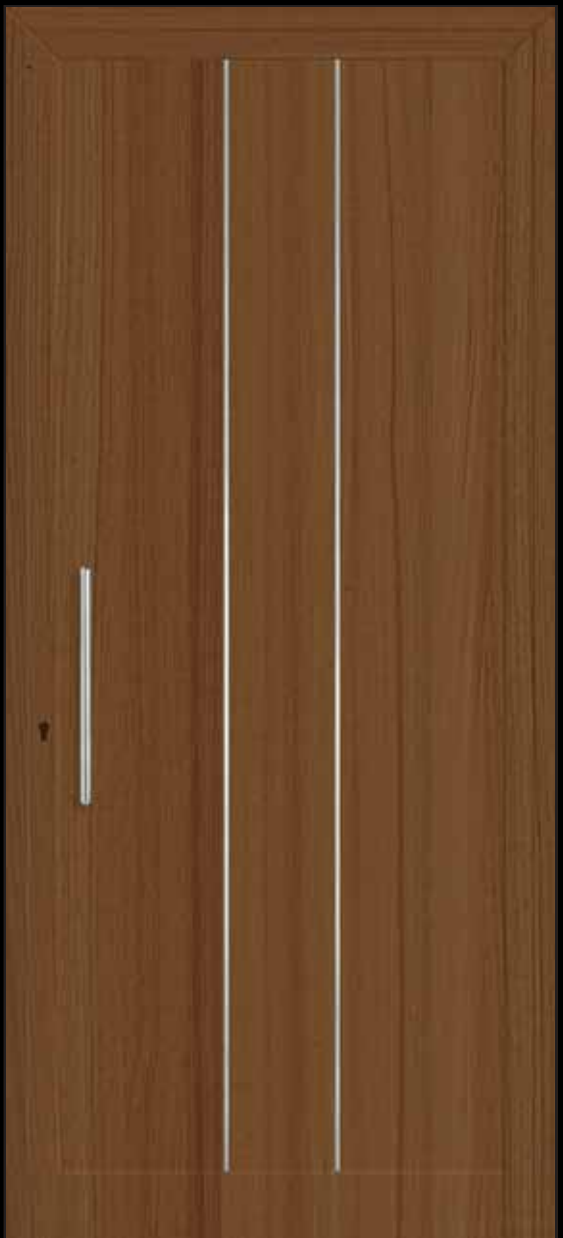

LR 19i / LR 5i / LR 13i / LR 20i / LR 7i

Painéis Retiline







LR 7
Panel Retline



LR 7 i
Panel Retline



LR 8
Panel Retline



LR 8 ĩ
Panel Retline



LR 9
Panel Retline



LR 9 i
Panel Retline



LR 10

Paínel Retilina



LR 10 i

Paínel Retilina



LR 11

Panel Retline



LR 11 i

Panel Retline





LR 12

Panel Retline



LR 12 *á*

Panel Retline



LR 13i / LR 20i / LR 5i

Painéis Retiline







LR 13
Paínel Retilíne



LR 13 ĩ
Paínel Retilíne



LR 14
Panel Retline



LR 14 ĩ
Panel Retline



LR 15
Paanel Retilne



LR 15 Ā
Paanel Retilne



LR 16

Panel Retline



LR 16 ĩ

Panel Retline





LR 17
Panel Retline

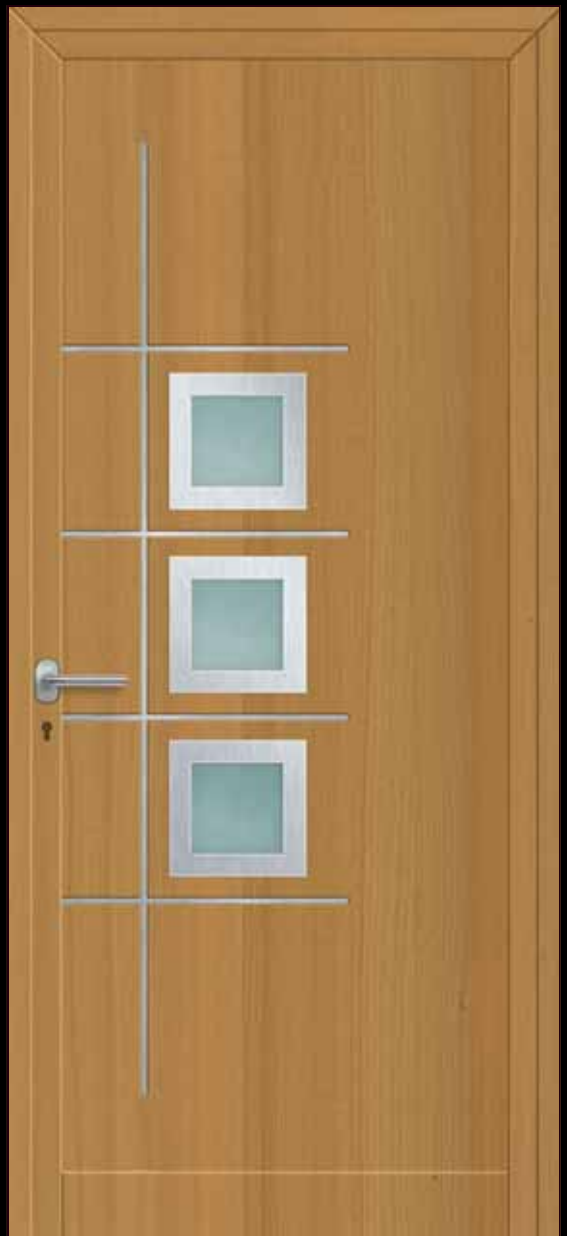

LR 17 ĩ
Panel Retline



LR 18
Paínel Retilino



LR 18 *á*
Paínel Retilino

LR 21i / LR 17i / LR 12i

Painéis Retiline





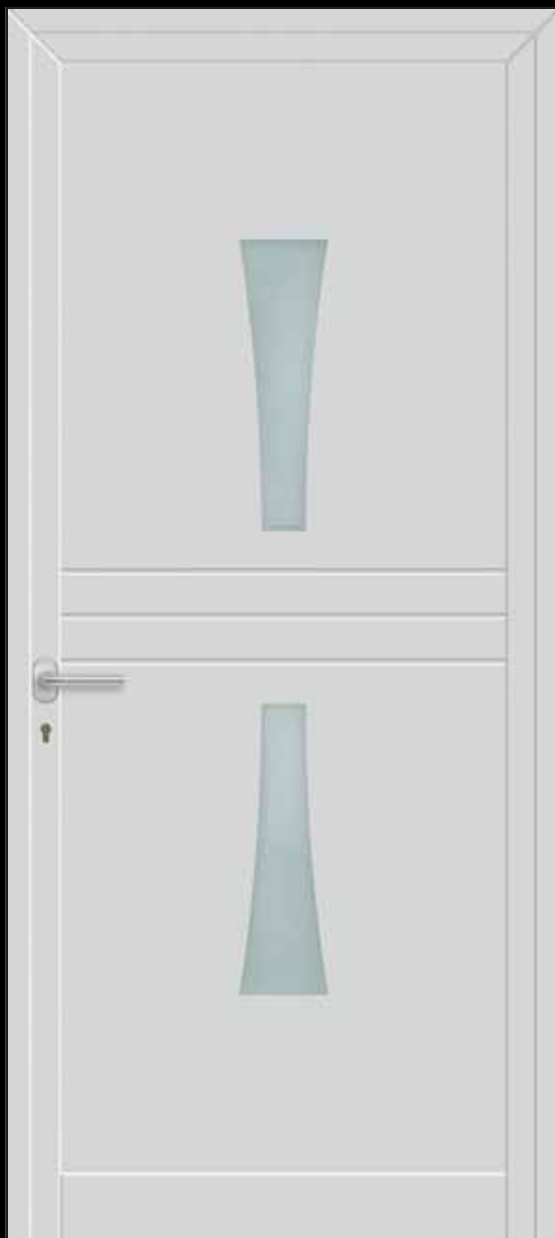

LR 19
Patmel Restline



LR 19 ĩ
Patmel Restline



LR 20

Panel Retline



LR 20 i

Panel Retline





LR 21
Panel Retline



LR 21 *á*
Panel Retline





PAINÉIS LINE FASHION

PANELES // PANNEAUX // PANELS

Índice

LF 1 (*)	LF 2 (*)	36
LF 3	LF 4 (**)	37
LF 5	LF 6 (*)	38
LF 7 (*)	LF 8 (*)	39
LF 9	LF 10	40
LF 11 (*)	LF 12 (**)	41
LF 13 (*)	LF 14 (*)	42
LF 15	LF 16 (*)	43
LF 17 (*)	LF 18	46
LF 19 (**)	LF 20 (**)	47
LF 21 (*)	LF 22 (*)	48
LF 23	LF 24 (**)	49
LF 25 (*)	LF 26	50
LF 27	LF 28	51
LF 29 (*)	LF 30 (*)	52
LF 31	LF 32	53
LF 33	LF 34	56
LF 35 (**)	LF 36	57
LF 37	LF 38	58
LF 39	LF 40	59
LF 41	LF 42	60
LF 43 (**)	LF 44 (*)	61
LF 45 (**)	LF 46	62
LF 47 (*)	LF 48	63
LF 49 (*)		66

(*) Estampados

(*) Estampados

(*) Emboutis

(*) Pressed



(**) Maquinados

(**) Mecanizados

(**) Usiné

(**) Machined





LF1
Painel Line Fashion



LF2
Painel Line Fashion





LF3
Painel Line Fashion

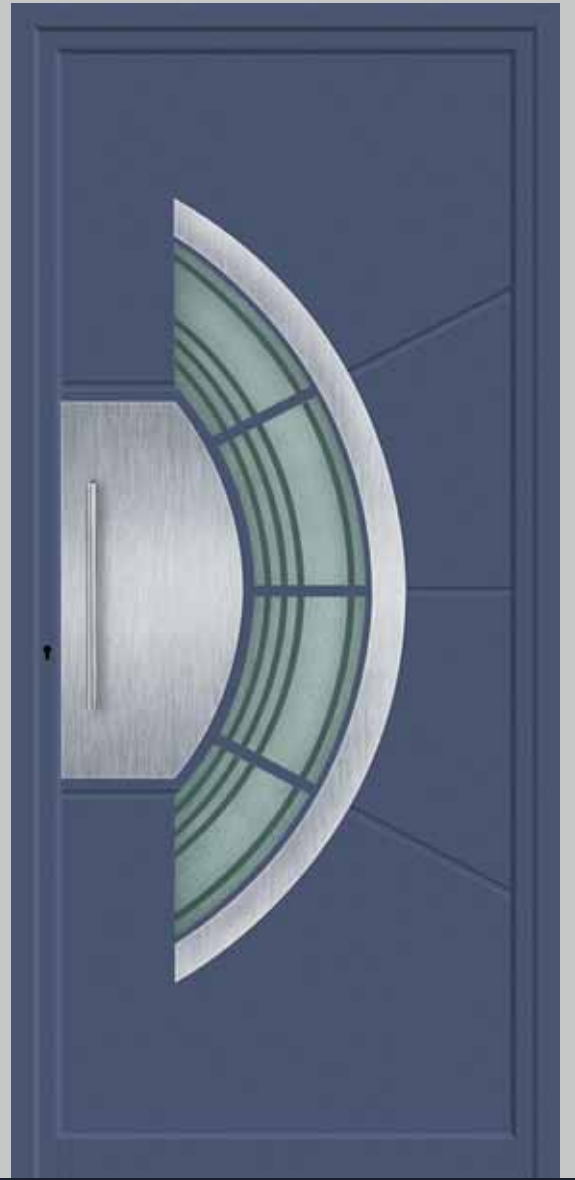

LF4
Painel Line Fashion





LF5
Painel Line Fashion



LF6
Painel Line Fashion





LF7
Painel Line Fashion

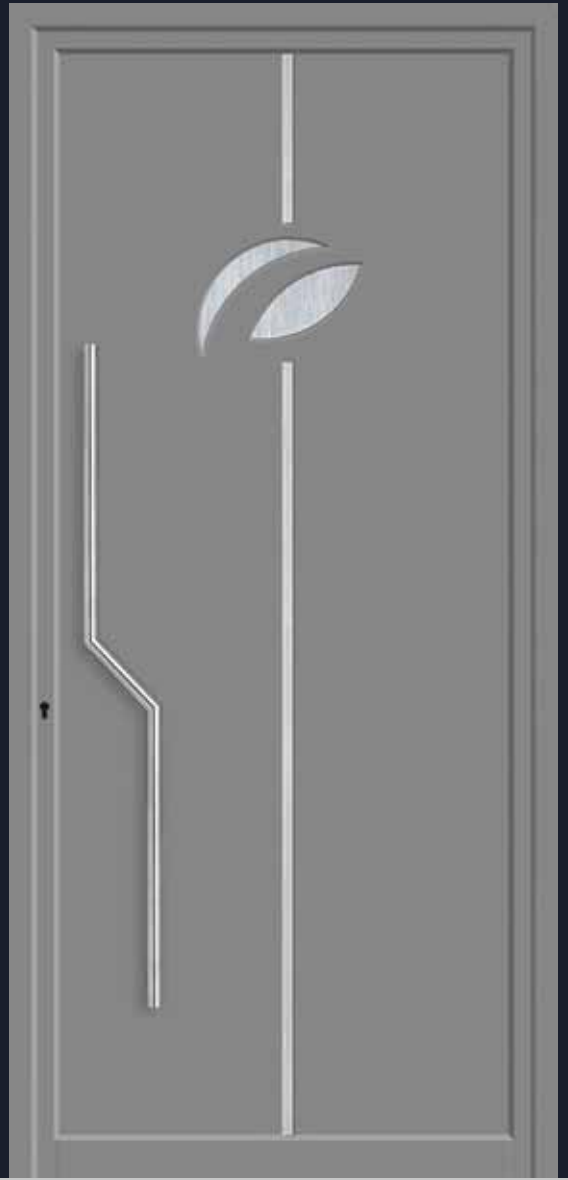

LF8
Painel Line Fashion





LF9
Painel Line Fashion



LF10
Painel Line Fashion





LF11
Painel Line Fashion



LF12
Painel Line Fashion





LF13
Painel Line Fashion



LF14
Painel Line Fashion



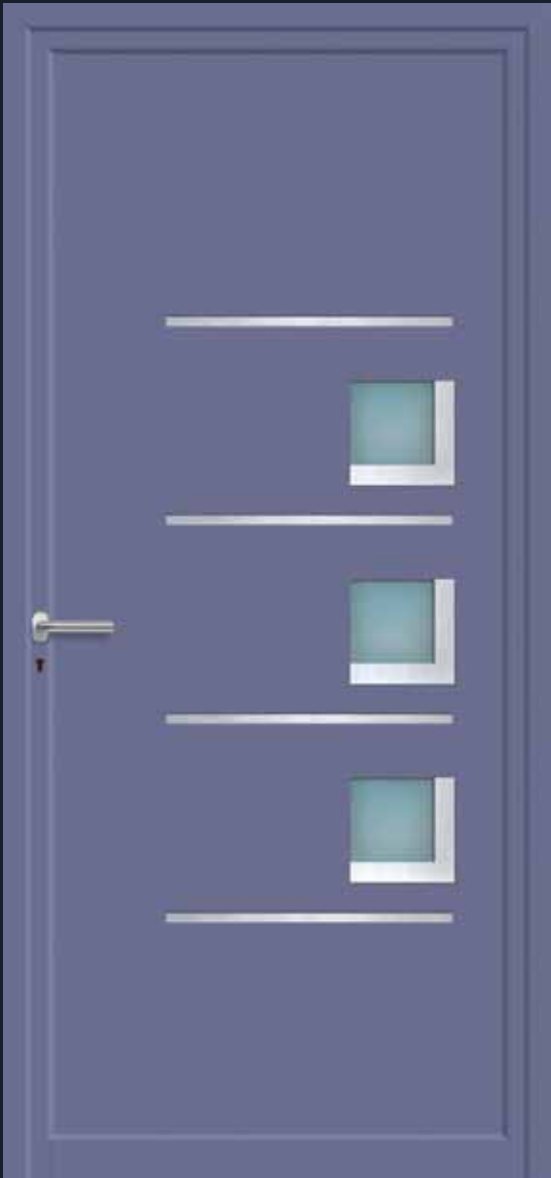

LF15
Painel Line Fashion



LF16
Painel Line Fashion





LF49 / LF43 / LF27



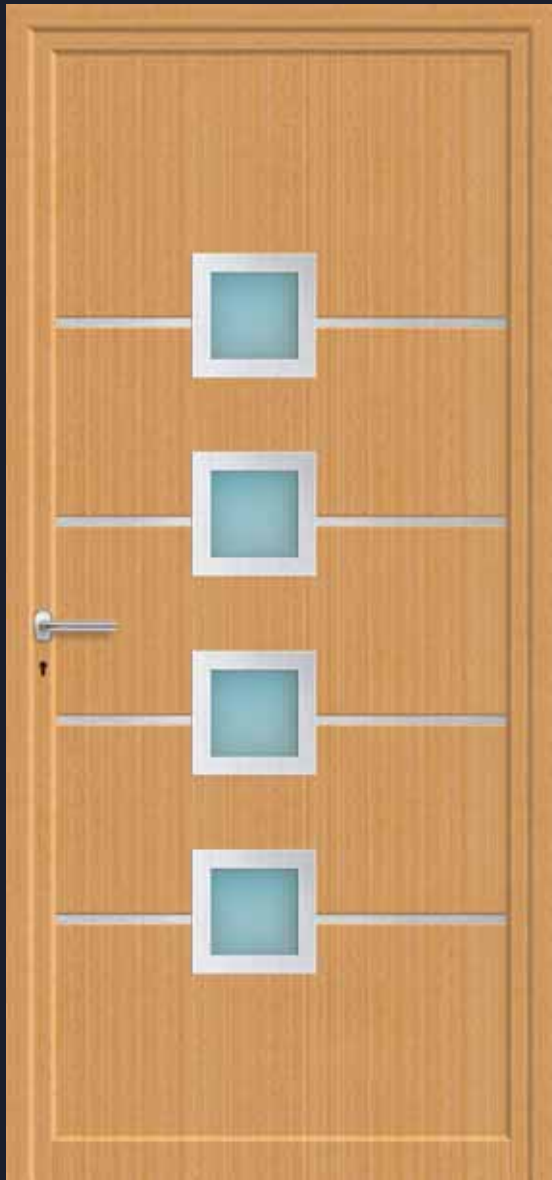

LF17
Painel Line Fashion

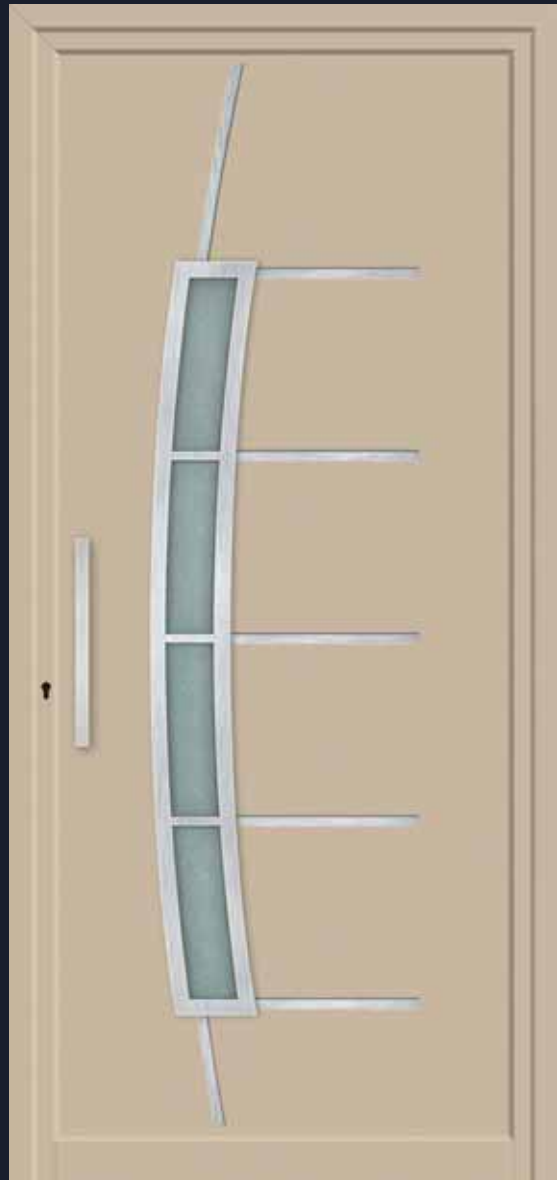

LF18
Painel Line Fashion





LF19
Painel Line Fashion



LF20
Painel Line Fashion





LF21
Painel Line Fashion



LF22
Painel Line Fashion





LF23
Painel Line Fashion



LF24
Painel Line Fashion

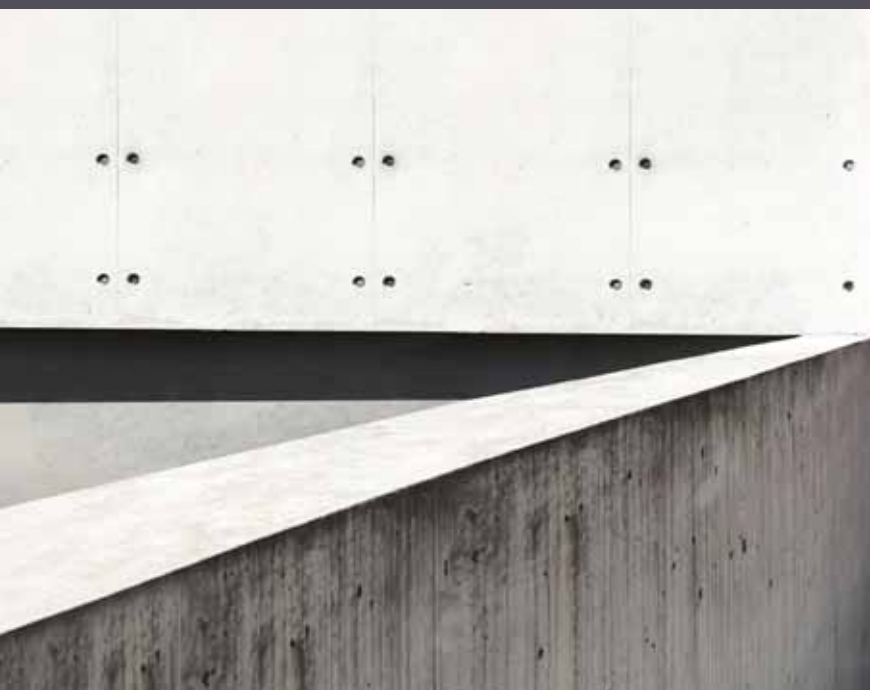



LF25
Painel Line Fashion

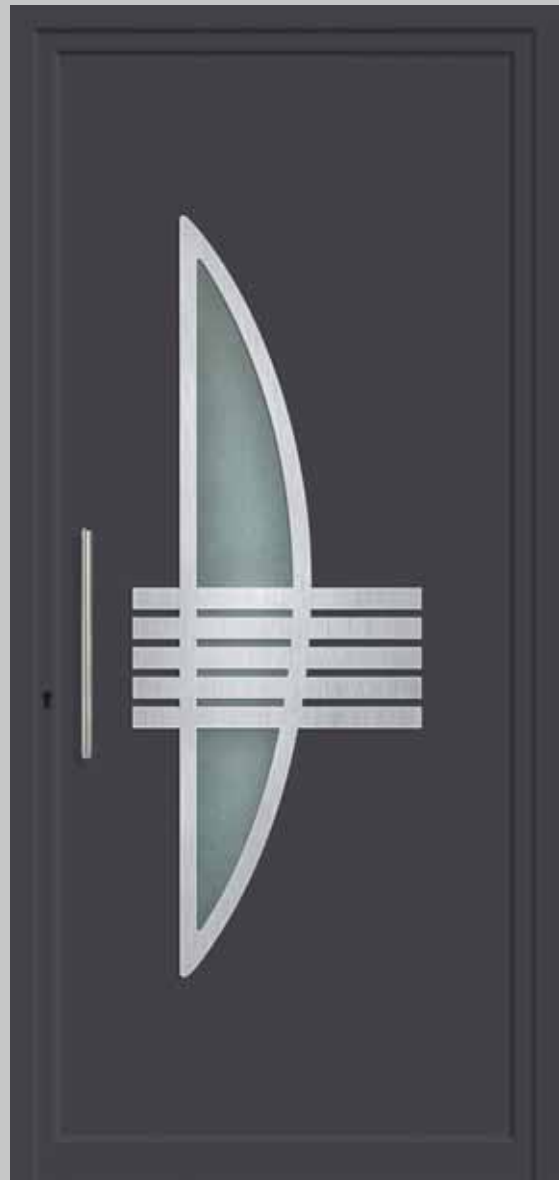

LF26
Painel Line Fashion





LF27
Painel Line Fashion



LF28
Painel Line Fashion





LF29
Painel Line Fashion



LF30
Painel Line Fashion





LF31
Painel Line Fashion

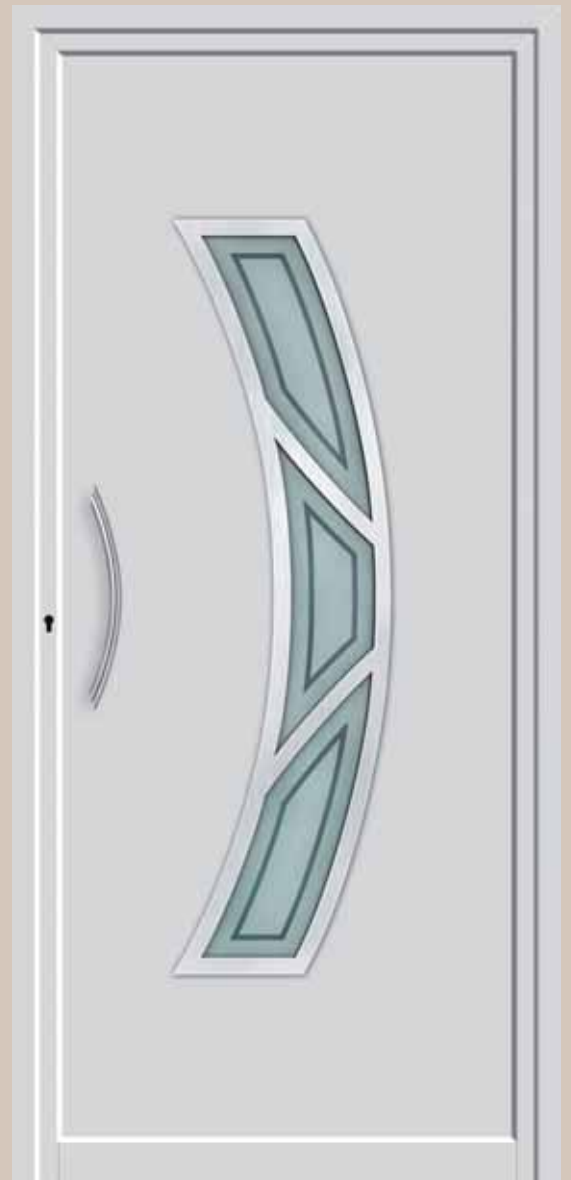

LF32
Painel Line Fashion





LF4 / LF3 / LF10

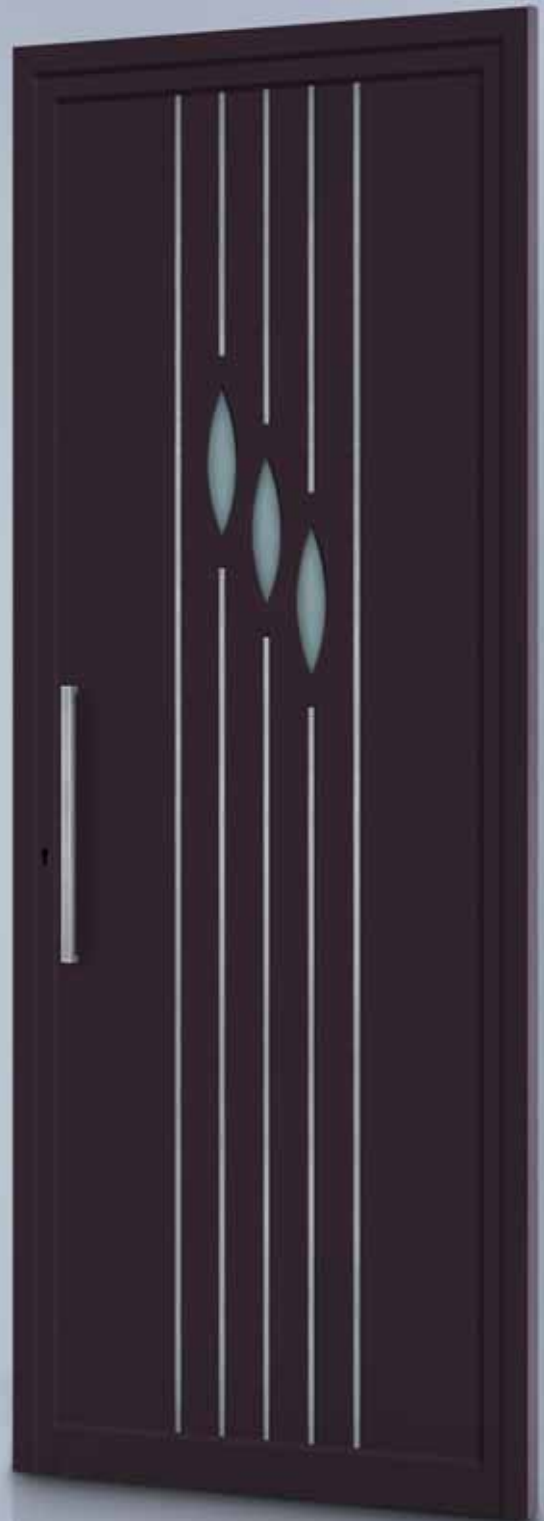

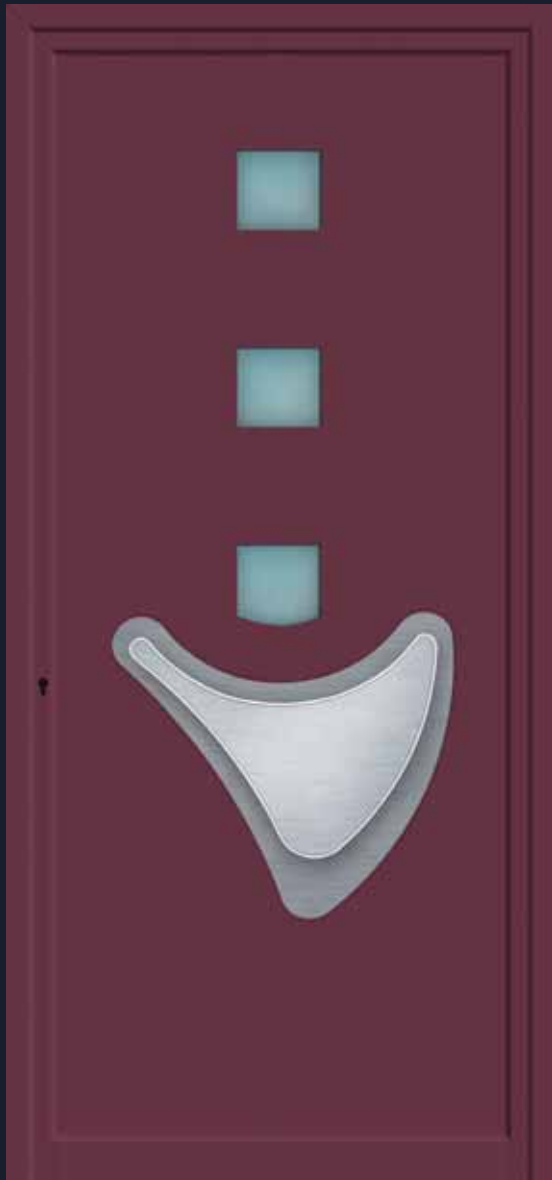

LF33

Painel Line Fashion

produto registado bramolde, inovador e exclusivo para estes painéis/puxadores

LF34

Painel Line Fashion

produto registado bramolde, inovador e exclusivo para estes painéis/puxadores





LF35
Painel Line Fashion

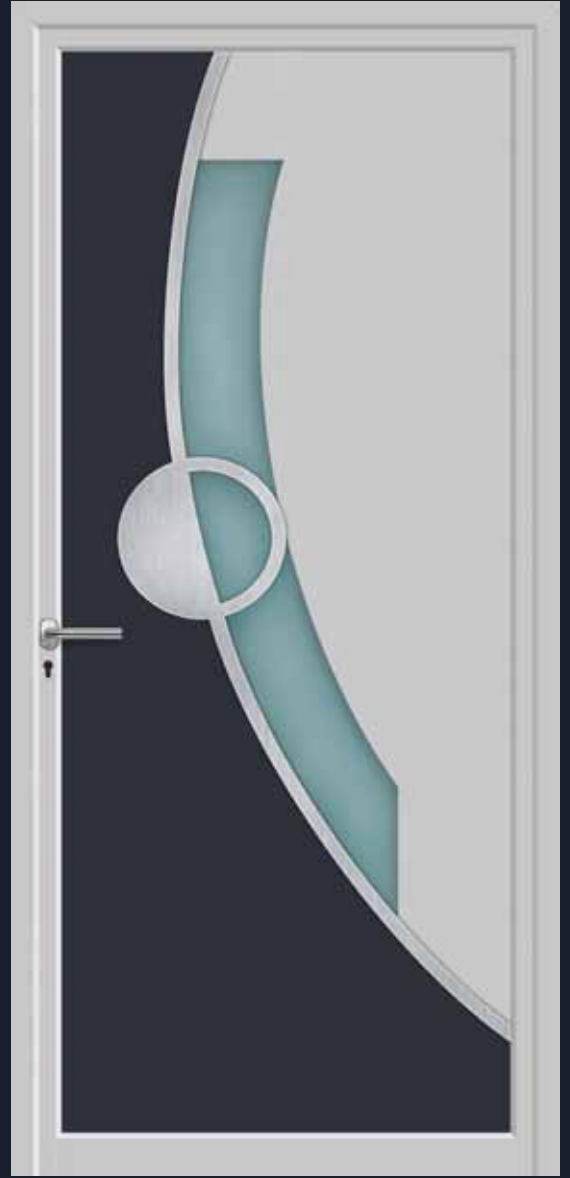

LF36
Painel Line Fashion





LF37
Painel Line Fashion

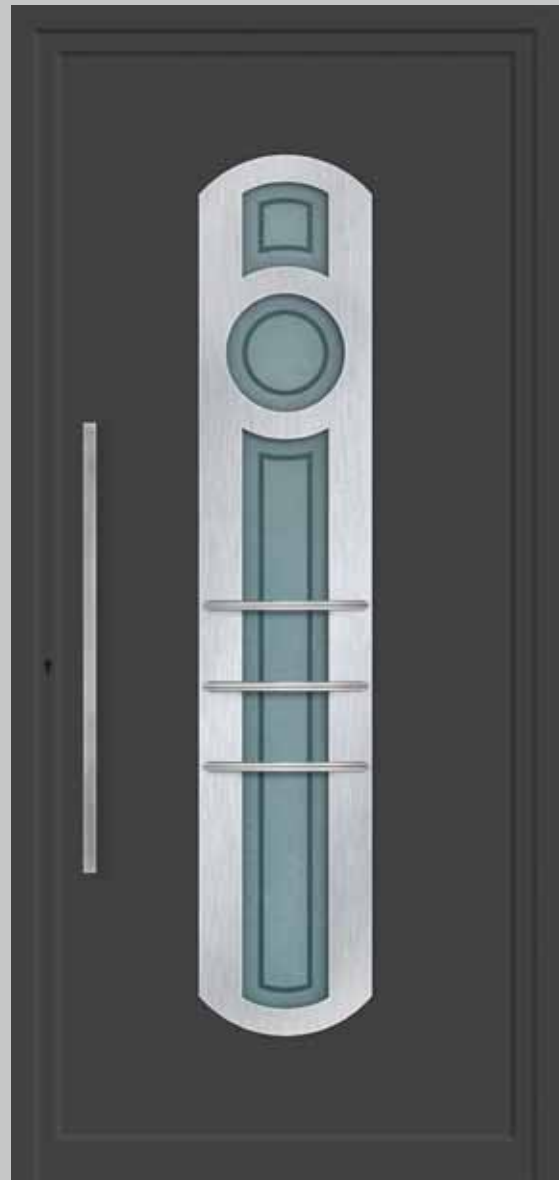

LF38
Painel Line Fashion





LF39
Painel Line Fashion



LF40
Painel Line Fashion





LF41
Painel Line Fashion



LF42
Painel Line Fashion





LF43
Painel Line Fashion



LF44
Painel Line Fashion



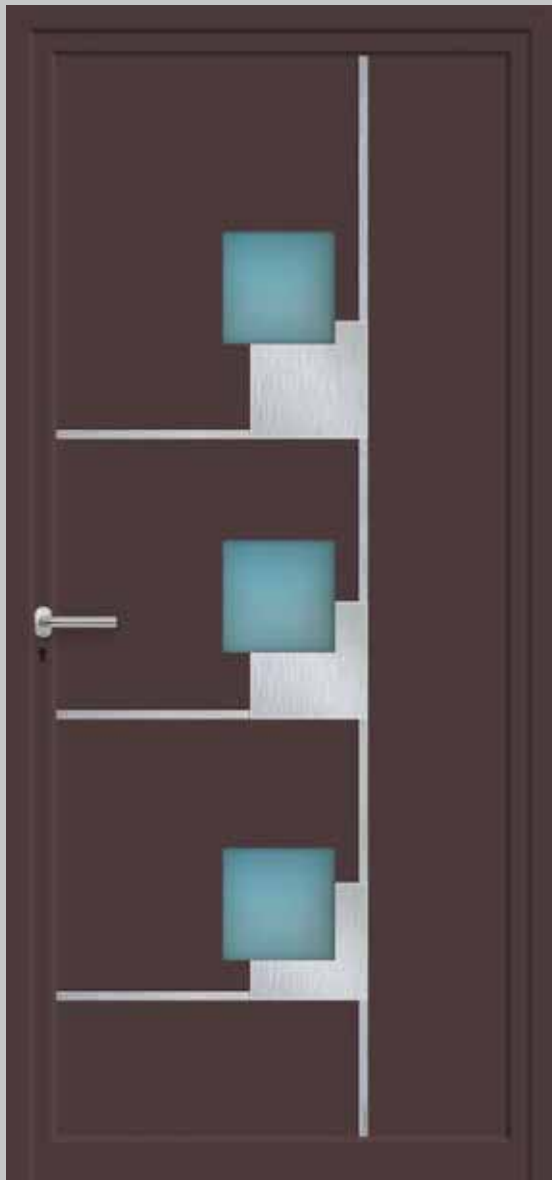

LF45
Painel Line Fashion



LF46
Painel Line Fashion





LF47
Painel Line Fashion



LF48
Painel Line Fashion

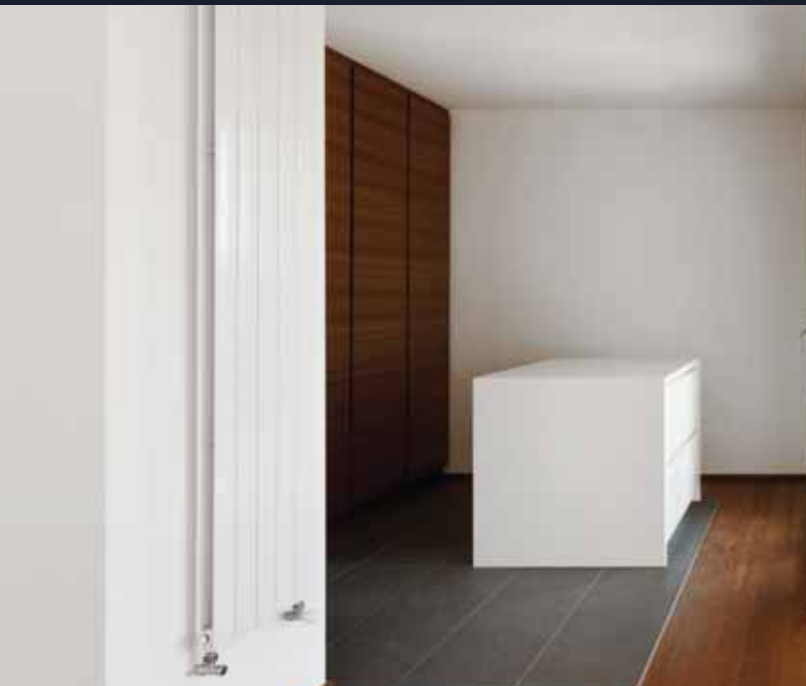



LF18 / LF46 / LF42





LF49

nl

New Line Series

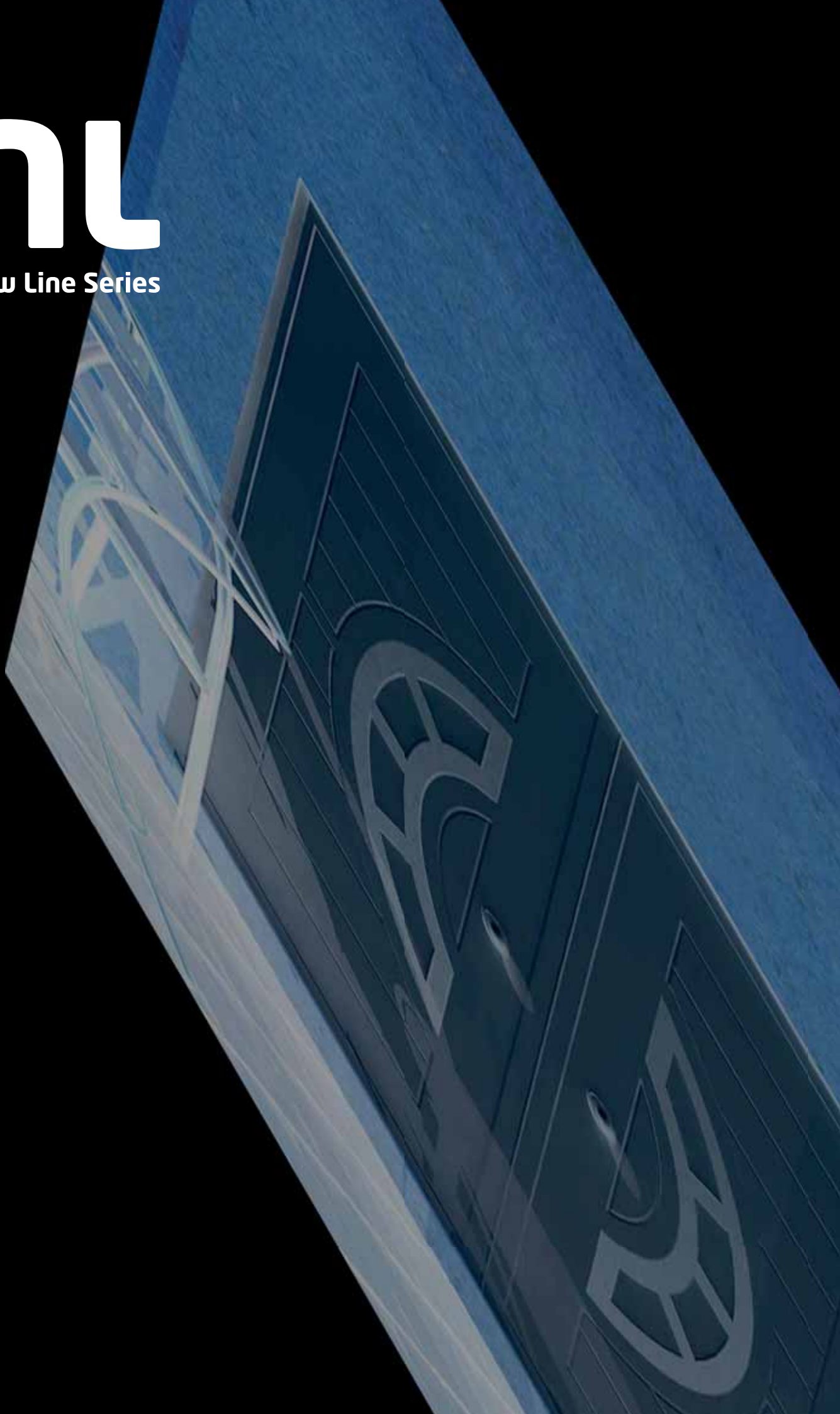

Índice

NL 1 (*)	70
NL 2 (*)	72
NL 3 (**)	74
NL 4 (*)	76
NL 5 (**)	78
NL 6 (**)	80
NL 7 (**)	82
NL 8 (*)	84
NL 9 (**)	86
NL 10 (**)	88
NL 11 (**)	90
NL 12 (*)	92
NL 13 (**)	94
NL 14 (**)	96
NL 15 (**)	98
NL 16 (**)	100

(*) Estampados

(*) Estampados

(*) Emboutis

(*) Pressed



(**) Maquinados

(**) Mecanizados

(**) Usiné

(**) Machined



NL1

new line series

2i





Ci

Ri



C



Z



R

NL2
new line series

Ri



2i



2



A



C



Ci

NL3

new line series

A



C

Ri



Ci

2i

2

NL4

new line series

21

2



A



Ai



C

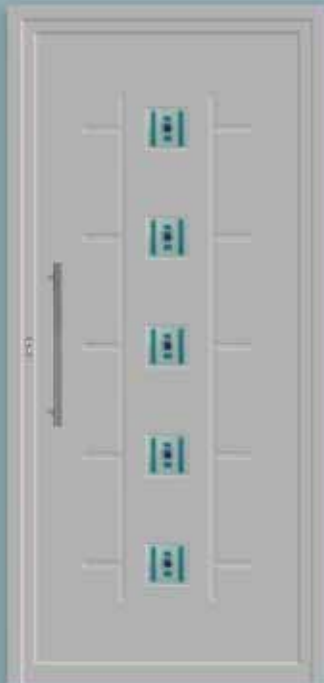

Ci



NL5

new line series

A



2

2i



Ci



C



Ai



NL6
new line series

2



A

C

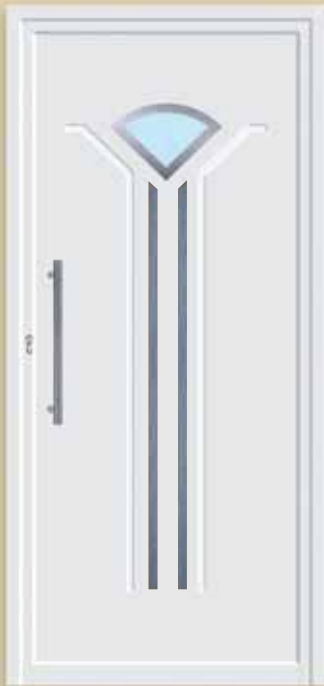

Ai

Zi

Ci

NL7

new line series



A

2i

2



Ci

Ai

C

NL8

new line series

Ai

2i



A

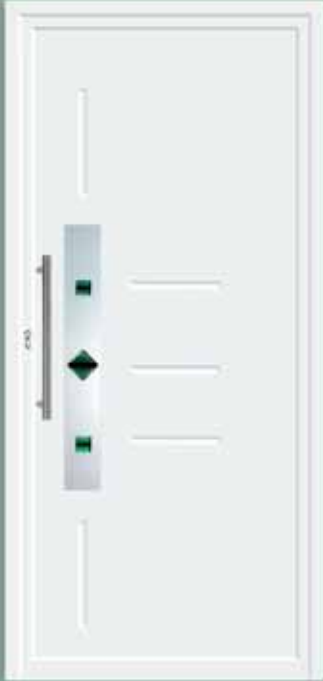

2

C



Ci

NL9

new line series



A

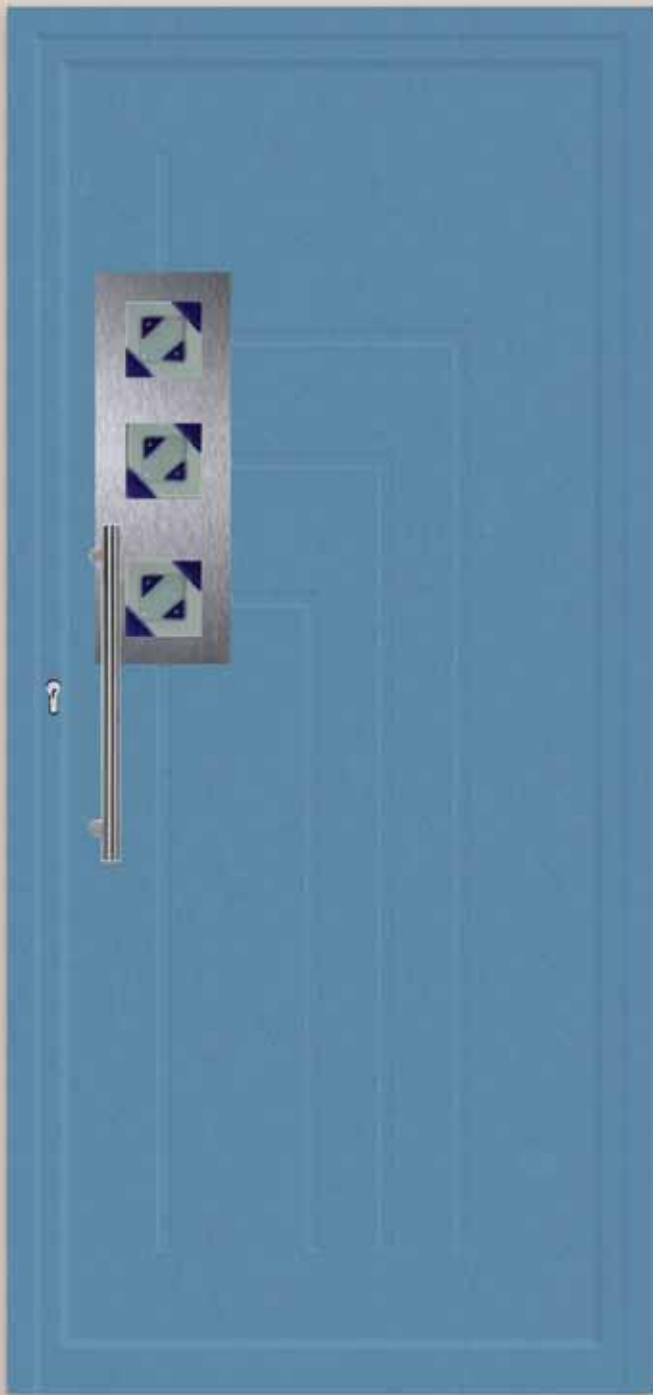

Ci

2i



Ai

2



c

NL10

new line series

Ri



NL10

new line series

2i



A



2

C

Ci



nl11

new line series

Ri

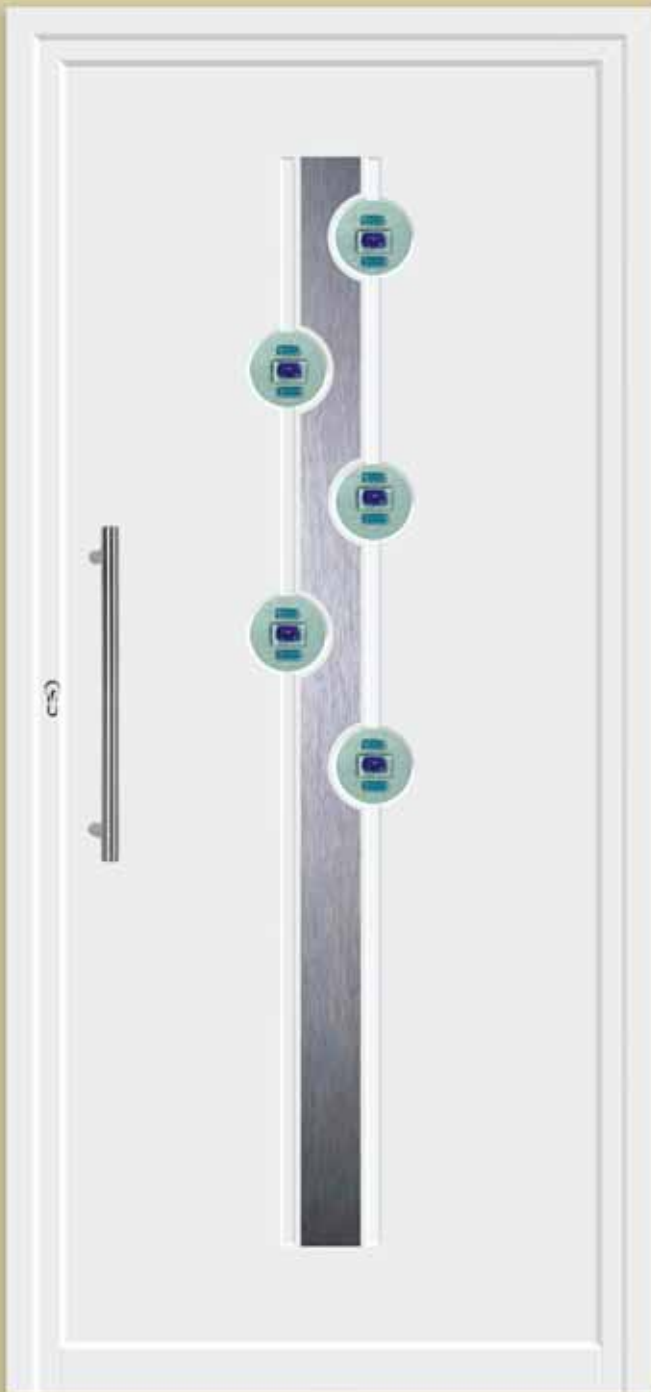

Ci

Z



R

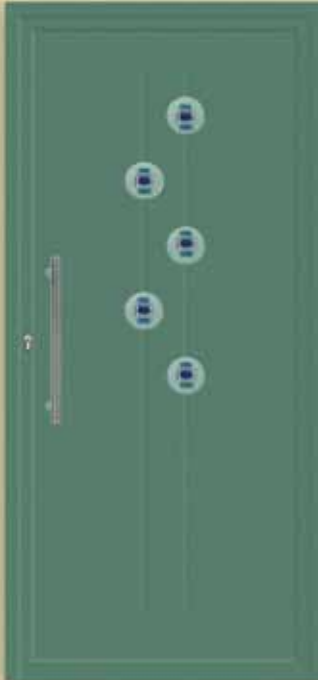

C



Zi

NL12

new line series

Ai

NL12

new line series

A

Z



Zi

C

Ci

NL13

new line series

Ai

NL13

new line series

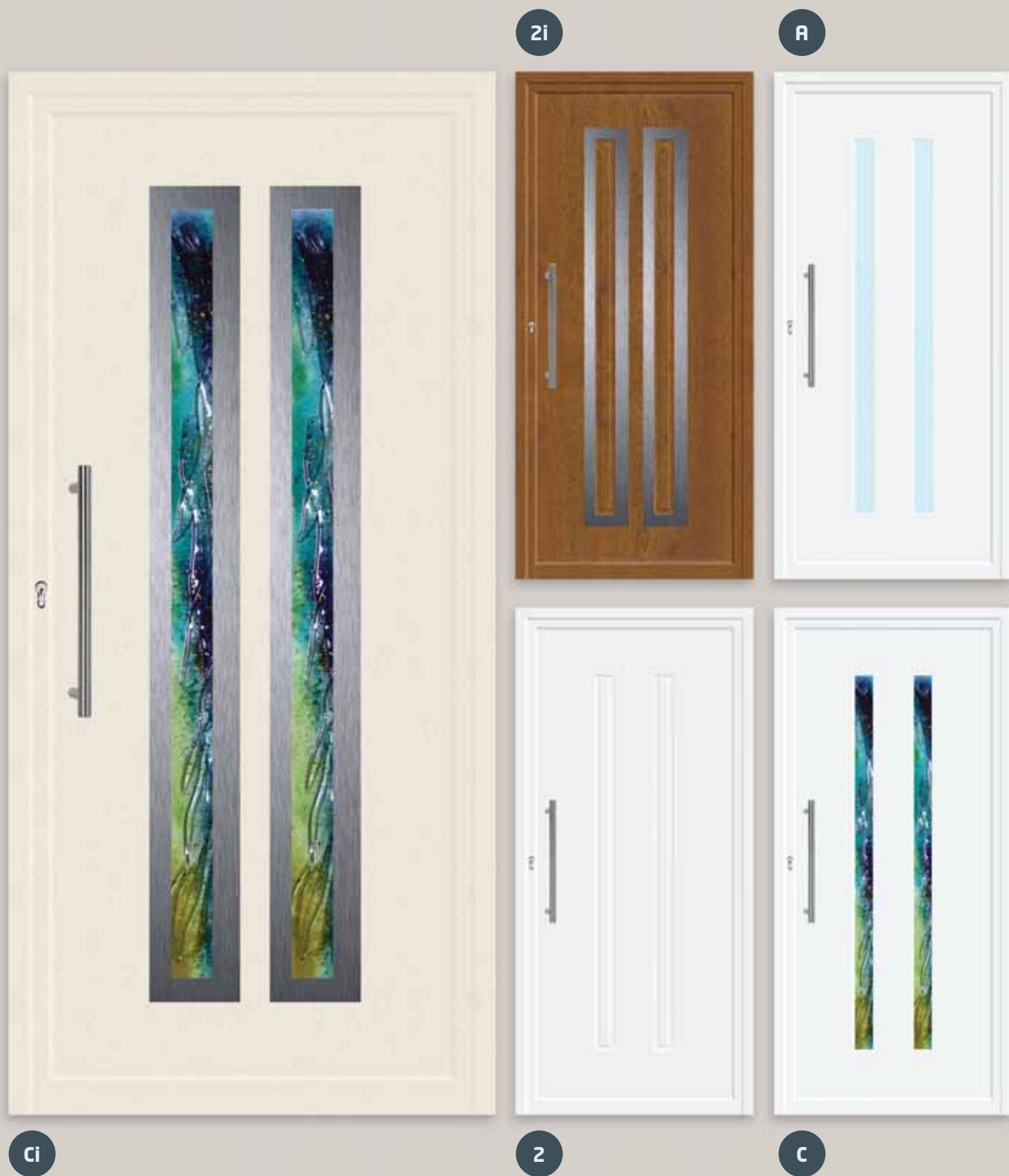

NL14

new line series

2i



2

A



Ai

C

Ci

NL15

new line series



NL15

new line series

2

2i



Ci

C

Ai

NL16

new line series

AI

NL16

new line series

2



2i



A



C



Ci



PAINÉIS ARO OCULTO
PANELES ARO OCULTO
PANNEAUX OUVRANT CACHÉ
PANELS HIDDEN FRAME







PAINÉIS ARO OCULTO:

Os aros são montados entre as duas faces do painel, não sendo visíveis quando se observa o painel de frente ou de trás. Só possível em painéis lisos ou fresados, com/sem vidro, mediante orçamento

PANELES ARO OCULTO:

Los perfiles se montan entre las dos caras del panel y no son visibles al mirar el panel frontal o posterior. Solo es posible en paneles lisos o fresados con / sin cristal, Bajo presupuesto

PANNEAUX OUVRANT CACHÉ:

Les profilés sont montés entre les deux faces du panneau et ne sont pas visibles lorsque vous regardez le panneau avant ou arrière.

Solo es posible en paneles lisos o fresados con / sin cristal, Bajo presupuesto

PANELS HIDDEN FRAME:

The profiles are mounted between the two panel faces and are not visible when looking at the front or rear panel.

Upon Budget, only possible on plain or milled panels with / without glass



Exemplo:
Modelo LineFashion LF 49



INFORMAÇÕES DIVERSAS

INFORMACIÓN DIVERSA

INFORMATION MISCELLANEOUS

MISCELLANEOUS INFORMATION

INJEÇÃO DE POLIURETANO

Mediante orçamento poderemos disponibilizar a injeção de espuma de poliuretano nos mais variados artigos, como por exemplo perfis de alumínio, perfis de alumínio de rotura térmica ou outros.

INYECCIÓN DE POLIURETANO

Mediante presupuesto podemos disponibilizar la inyección de espuma de poliuretano en los más variados artículos, como por ejemplo perfiles de aluminio, con o sin ruptura térmica.

INJECTION DE POLYURÉTHANE

Sur un budget, nous pouvons offrir l'injection de mousse de polyuréthane dans divers articles tels que des profilés en aluminium, sans ou avec rupture thermique.

POLYURÉTHANE INJECTION

On a budget, we can offer the injection of polyurethane foam in various articles such as aluminum profiles, without or with thermal break.

CHAPAS PARA PORTAS DE SEGURANÇA

Na área das portas de segurança, além das tradicionais chapas de painel estampadas para revestir portas de segurança, a Bramolde oferece a seguinte solução para esta área:

Chapas de painel (2100x1000), lisas ou estampadas, c/ injeção de poliuretano, para uma espessura final total de 6mm.

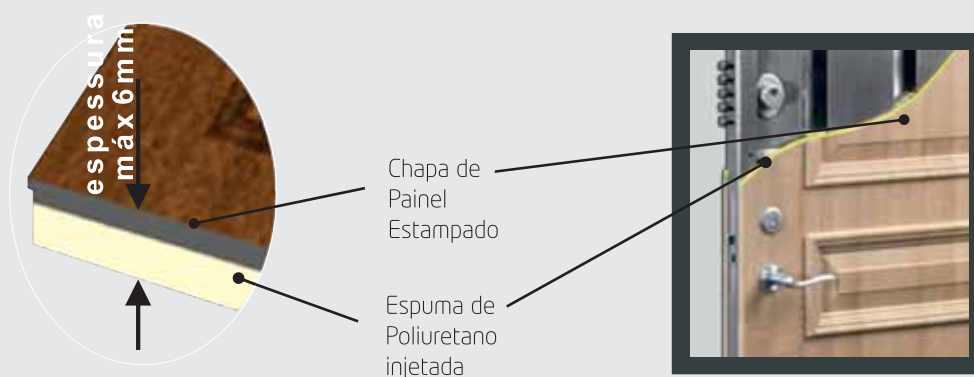

CHAPAS PARA PUERTAS DE SEGURIDAD

En el área de las puertas de seguridad, además de las tradicionales chapas de panel estampadas para revestir puertas de seguridad, Bramolde ofrece la siguiente solución innovadora para esta área:

Chapas de panel (2100x1000), lisas o estampadas, con inyección de poliuretano, para un espesor final total de 6mm.

PLANCHES POUR LES PORTES DE SÉCURITÉ

Dans le domaine des portes de sécurité, en plus des panneaux traditionnels emboutis pour recouvrir les portes de sécurité, Bramolde propose la solution innovante suivante pour ce domaine:

Plaques de panneaux simples ou emboutis (2100x1000), avec injection de polyuréthane, pour une épaisseur finale totale de 6mm.

PLATES FOR SECURITY DOORS

In the area of security doors, in addition to the traditional stamped panels to coat security doors, Bramolde offers the following innovative solution for this area:

Plain or stamped panels (2100x1000), with polyurethane injection, for a total final thickness of 6mm.

NOTA: Neste processo não é possível injetar chapas RÉGUA, ANADIA, ANGRA, ÍLHAVO, nem chapas Retiline.

NOTA: En los paneles con un estampado en relieve negativo (Anadia, Angra, Ílhavo, Régua y RETILINE) no se puede inyectar poliuretano para el espesor total de 6mm.

REMARQUE: Sur les panneaux avec emboutissage négatif (Anadia, Angra, Ílhavo, Régua et RETILINE), il est impossible d'injecter du polyuréthane pour une épaisseur totale de 6 mm

NOTE: On panels with negative stamping (Anadia, Angra, Ílhavo, Régua and RETILINE) it is not possible to inject polyurethane for the total thickness of 6mm.

PERFIS DE ALUMÍNIO

Disponibilizamos, mediante orçamento, a injeção de poliuretano em perfis, normais e/ou de rotura térmica.

Em comprimento superior a 3 metros só se efetua mediante análise detalhada do tipo de artigo referido no pedido de orçamento.

PERFILES DE ALUMINIO

Ofrecemos, dentro del presupuesto, la inyección de poliuretano en perfiles, rotura normal y / o térmica.

La inyección de poliuretano en perfiles, normales y de ruptura térmica, de longitud superior a 3 metros sólo se efectúa mediante consulta y presupuesto.

PROFILS EN ALUMINIUM

Nous proposons, dans les limites du budget, l'injection de polyuréthane dans les profilés, à rupture normale et / ou thermique.

L'injection de polyuréthane dans des profils normaux et de rupture thermique, de longueur supérieure à 3 mètres il ne fonctionne que sur demande et le budget.

ALUMINUM PROFILES

We provide, upon budget, the polyurethane injection profiles in normal and / or thermal break.

The injection of polyurethane in profiles, normal and of thermal rupture, of Length greater than 3 meters it is only done through consultation and budget

PERFIL DE ROTURA TÉRMICA

Perfil que permite a redução na condutividade térmica, pela inclusão de uma interface composta por poliamida e injeção de poliuretano.

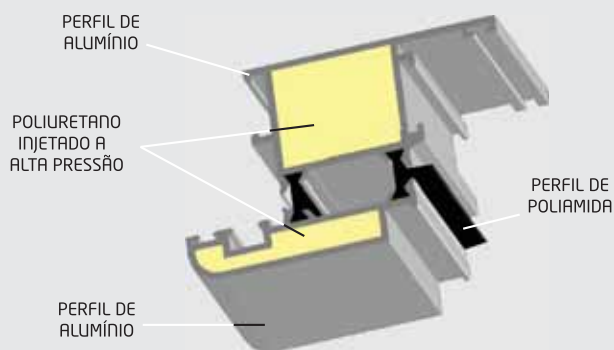
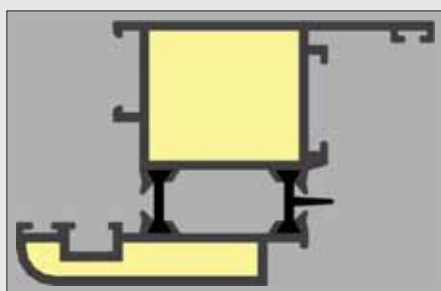

PERFIL DE ROTURA TERMICA

Perfil que permite la reducción en la conductividad térmica, por la inclusión de una interfaz compuesta por poliamida e inyección de poliuretano.

PROFIL DE RUPTURE THERMIQUE

Profil qui permet la réduction de la conductivité thermique, par l'inclusion d'une interface composée d'injection de polyamide et de polyuréthane.

THERMAL BREAK PROFILE

Profile that allows the reduction in the thermal conductivity, by the inclusion of an interface composed of polyamide and polyurethane injection.

ESTUDO

Pesquisa da melhor solução preço/qualidade que responda às solicitações do mercado.

ESTUDIO

Búsqueda de la mejor solución precio / calidad que responda a las solicitudes del mercado.

ÉTUDE

Recherchez la meilleure solution qualité / prix qui répond aux demandes du marché.

STUDY

Search for the best price / quality solution that responds to market requests.

FABRICO

Utilização de diferentes tipos de equipamento (cnc, electroerosão, têmpera, corte e estampagem) que melhor se adequem à obtenção do produto.

FABRICACIÓN

Utilización de diferentes tipos de equipo (CNC, electroerosión, temple, corte y estampado,...) Que mejor se adecuen a la obtención del producto.

FABRICATION

Utilisation de différents types d'équipements (cnc, électroérosion, trempe, découpe et emboutissage, ...) Le mieux adapté à l'obtention du produit.

MANUFACTURING

Use of different types of equipment (cnc, electro erosion, tempering, cutting and stamping ...) Best suited to obtaining the product.



Destacam-se os seguintes tipos de produtos:

- Fabrico de moldes para fundição injetada / fundição por gravidade.
- Fabrico de cunhos e cortantes para alumínio.
- Fabrico de prototipos.



Se destacan los siguientes tipos de productos:

- Fabricación de moldes para Fundición por inyección / fundición por gravedad.
- Fabricación de matrices y cortadores para aluminio.
- Fabricación de prototipos.

PROJECTO

Utilização dos mais avançados meios tecnológicos de CAD / CAM para a adaptação das diferentes soluções aos meios e processos de fabrico.

PROYECTO

Utilización de los más avanzados medios tecnológicos de CAD / CAM para la adaptación de las diferentes soluciones a los medios y procesos de fabricación.

PROJET

Utilisation des moyens technologiques les plus avancés de CAD / Cam pour l'adaptation des différentes solutions aux moyens et procédés de fabrication.

PROJECT

Using the most advanced technological means of CAD / CAM for the adaptation of the different solutions to the means and processes of manufacture.

EXECUÇÃO

Operações de montagem de subprodutos e acabamento superficial que permitam a completa satisfação das expectativas do mercado.

EJECUCIÓN

Operaciones de montaje de sub-productos y acabado superficial (thermo-lacado, anodización,...). Que permitan la completa satisfacción de las expectativas del mercado.

EXÉCUTION

Opérations de sous-assemblage et de finition de surface (thermo-laquage, anodisation, ...) Cela permet la satisfaction totale des attentes du marché.

EXECUTION

Sub-assembly and surface finishing operations (thermo-lacquering, anodizing ...) that allow the complete satisfaction of market expectations.



Les types de produits suivants se distinguent:

- Fabrication de moules pour la coulée sous pression / coulée par gravité.
- Fabrication de matrices et couteaux pour l'aluminium.
- Fabrication de prototypes.



The following types of products stand out:

- Manufacture of molds for Injection casting / gravity casting.
- Stamps and Cutters Manufacture for aluminium.
- Prototype manufacturing.

ACABAMENTOS

ACABADOS / FINITIONS / FINISHES



TIPOS DE ACABAMENTO

Os painéis de portas de alumínio podem ser fornecidos nos mais diversos tipos de acabamentos: anodizados, lacados de imitação madeira, película de PVC (RENOLITE) e cores Ral. A escolha pode contemplar um elevado número de possibilidades. A todas as solicitações dedicaremos a nossa melhor atenção, no sentido de satisfazer as expectativas dos nossos parceiros e clientes.

NOTA IMPORTANTE

Acabamento em película de PVC (RENOLITE) apenas disponível para painéis estampados e painéis lisos.

No caso de reprodução de acabamento igual ao de uma amostra, o resultado final pode não coincidir com o da amostra fornecida ou das amostras que constam no catálogo, devido aos tipos de material e aos processos de produção envolvidos.

Nos painéis estampados, a lacagem só é efetuada depois das operações de estampagem e corte das aberturas.

Mediante o pedido de orçamento prévio fornecemos barrotinhos, barrotes e grades na mesma cor do painel.



TIPOS DE ACABADO

Los paneles de puertas de aluminio pueden ser proveídos en los más diversos tipos de acabados: anodizados, lacados de imitación madera, Renolit y colores Ral.

La elección puede contemplar un elevado número de diferentes posibilidades. A todas las solicitudes dedicaremos nuestra mejor atención, con la intención de satisfacer las expectativas de nuestros socios y clientes.

NOTA IMPORTANTE

Renolites solo es posible en paneles estampados o lisos.

En caso de reproducción de acabado igual al de una muestra, el resultado final podrá no coincidir con el de la muestra proporcionada o de las muestras que constan en el catálogo, debido a los tipos de material y a los procesos de producción involucrados.

En los paneles estampados, el lacado sólo se efectúa después de las operaciones de estampado y corte de las aperturas.

Mediante solicitud de presupuesto previo suministramos barrotillos, barras y rejas en el mismo color de la puerta.

ELEVADO NÚMERO DE CORES

ALTO NÚMERO DE COLORES

NOMBRE ÉLEVÉ DE COULEURS

HIGH NUMBER OF COLORS.





TYPES DE FINITION

Les panneaux de portes en aluminium peuvent être fournis dans les différents types de finitions: anodisés, imitation de bois, Renolit et les couleurs de la Gamme RAL.

Le choix peut contempler un grand nombre de différentes possibilités. Nous consacrerons notre attention à toutes les demandes, afin de répondre aux attentes des partenaires et des clients.

REMARQUE IMPORTANTE

Renolit seulement est possible pour panneaux emboutis et panneaux sans opérations de fraisage.

Dans le cas d'une reproduction du processus de finition conforme l'échantillon, le résultat final peut ne pas correspondre à l'échantillon fourni ou échantillons contenus dans le catalogue en raison des types de matériaux et de procédés de production impliqués.

Dans le panneau embouti, le laquage est effectué uniquement après le processus d'emboutissage et des ouvertures coupées.

À la demande du budget précédent nous fournissons croisillons, des poutres et des grilles dans la même couleur de la porte.



TYPES OF FINISH

Panels of aluminium doors can be supplied in various types of finishes: anodising, lacquered wood imitation, renolite and colours Range Ral.

The choice can contemplate a large number of different possibilities. For all requests we will dedicate our best attention in order to meet the expectations of partners and customers.

IMPORTANT NOTE

Renolit is only possible in pressed panels or in panels without any kind of machining.

In the case of a reproduction of a finishing process equal to a sample, the end result may not match the sample provided or samples contained in the catalogue due to the types of materials and production processes involved.

In pressed panels, the lacquering is only performed after the pressed operations and cut openings.

At the request of previous budget we provide bars, strips and grids in the same colour of the door.

DIFERENTES POSSIBILIDADES DE IMITAÇÃO MADEIRA

DIFERENTES POSIBILIDADES DE IMITACIÓN MADERA

DIFFÉRENTES POSSIBILITÉS D'IMITATION DE BOIS

DIFFERENT WOOD IMITATION POSSIBILITIES



GOLDEN OAK

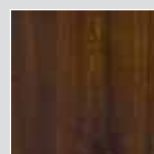

NOGAL



SAPELLI

CARACTERÍSTICAS TÉCNICAS

DATOS TÉCNICOS / CARACTÉRISTIQUES TECHNIQUES / TECHNICAL DATA



Painéis constituídos por duas chapas de alumínio, de espessura 1,5/1,8mm e poliuretano injetado, formando uma estrutura estratificada (sanduíche) com espessura standard 20/24mm.

O poliuretano (densidade de 90kg/m³) é injetado, permitindo chegar a todos os pontos do painel, resultando num produto final com maior resistência do que a obtida através de qualquer outro processo. As características finais dos painéis resultam do conjunto de características dos materiais e processos utilizados, sendo estas as mais importantes:

Elevado isolamento térmico / Elevado isolamento acústico / Resistência mecânica / Ligeireza / Baixa permeabilidade ao vapor de água / Estabilidade "in-situ" / Grande variedade de cores / Acabamentos disponíveis imitando os mais diversos tipos de madeira / Adaptável aos perfis de Alumínio e de PVC / Reciclável / Baixo custo

MEDIDAS: Standard - 2000x800mm // OUTRAS - sob consulta

CORES: Standard - Branco // OUTRAS-sob consulta

ESPESSURA MÁXIMA: 100 mm

CONDUTIBILIDADE TÉRMICA: EN 12 667 • 0,02777 W/m. °C

ISOLAMENTO ACÚSTICO

NP EN 20140-3:1998 / EN ISO 717-1:1996 • REF.2: R_w=-25dB (-1;-2) • REF.A: R_w=24dB (0;-2)



Panneaux constitués de deux feuilles d'aluminium, 1,5/1,8mm d'épaisseur et polyuréthane injecté, formant une structure stratifiée (sandwich) avec une épaisseur standard de 20/24mm.

Le polyuréthane (densité 90 kg/m³) est injecté, pour atteindre tous les points du panneau, résultant dans le produit final avec une grande résistance que celle obtenue par tout autre procédé. Les caractéristiques finales des panneaux sont le résultat des caractéristiques des matériaux et des procédés utilisés, ceux-ci étant les plus importants:

Isolation thermique élevée / Isolation acoustique élevée / Résistance mécanique / Légèreté / Faible perméabilité à la vapeur d'eau / Stabilité "in-situ" / Grande variété de couleurs / Processus de finition imitant divers types de bois disponibles / Adaptable aux profils en aluminium et PVC / Recyclable / Faible coût

MESURES: STANDARD - 2000x800 mm // AUTRES: Sur demande

COULEURS: STANDARD - Blanc //AUTRES: Sur demande

ÉPAISSEUR MAXIMA: 100 mm

CONDUCTIVITÉ THERMIQUE: EN 12 667 • 0,0277 W/m. °C

ISOLEMENT ACOUSTIQUE

NP EN 20140-3:1998 / EN ISO 717-1:1996 • REF.2: R_w=25dB (-1;-2) • REF.A: R_w=24dB(0;-2)



Paneles constituídos por dos chapas de aluminio, con espesor de 1,5/1,8mm y poliuretano inyectado, formando una estructura estratificada (sándwich) con espesor estándar de 20/24mm.

El poliuretano (densidad de 90kg/m³) es inyectado, permitiendo llegar a todos los puntos del panel, resultando en un producto final con mayor resistencia que la obtenida a través de cualquier otro proceso. Las características finales de los paneles resultan del conjunto de características de los materiales y procesos utilizados, siendo estas las más importantes: Elevado aislamiento térmico / Elevado aislamiento acústico / Resistencia mecánica / Ligeireza / Baja permeabilidad al vapor de agua / Estabilidad "in-situ" / Gran variedad de colores / Acabados disponibles imitando los más diversos tipos de madera / Adaptable a los perfiles de Aluminio y de PVC / Reciclable / Bajo coste

MEDIDAS: Estándar - 2000x800 mm // OTRAS - bajo consulta

COLORES: Estándar - Blanco // OTRAS - bajo consulta

ESPESOR MÁXIMO: 100 mm

CONDUCTIBILIDAD TERMAL: EN 12 667 • 0,0277 W/m. °C

AISLAMIENTO ACÚSTICO

NP EN 20140-3:1998 / EN ISO 717-1:1996 • REF.2: R_w=-25dB (-1;-2) • REF.A: R_w=24dB(0;-2)



Panels constituted of two aluminium sheets, 1,5/1,8mm thick and injected polyurethane, forming a stratified structure (sandwich) with standard thickness of 20/24mm

The polyurethane (density of 90kg/m³) is injected, reaching all panel points, resulting in a final product with greater resistance than that obtained by any other process. The final characteristics of the panel assembly are the result of the characteristics of the materials and processes used, these being the most important:

High thermal insulation / high acoustic insulation / Mechanical resistance / Lightness / Low permeability to water vapour / Stability "in-situ" / Wide variety of colours / Finishing process imitating various types of wood available / Adaptable to Aluminium and PVC profiles / Recyclable / Low cost

MEASURES: STANDARD - 2000x800 mm // OTHERS: On request

COLORS: STANDARD - White // OTHERS: On request

THICKNESS MAXIM: 100 mm

THERMAL CONDUCTIBILITY: EN 12 667 • 0,0277 W/m. °C

ACOUSTIC ISOLATION

NP EN 20140-3:1998 / EN ISO 717-1:1996 • REF.2: R_w=25dB (-1;-2) • REF.A: R_w=24dB(0;-2)

PAINÉIS ARO OCULTO

PANELES ARO OCULTO / PANNEAUX OUVRANT CACHÉ / PANELS HIDDEN FRAME



Só possível em painéis lisos ou fresados, com/sem vidro
Espessura de 88mm
Abertura de parede máxima para colocação da porta:
217,5x100,5 cm.

COMPOSIÇÃO:

- A** - 2 faces chapa de alumínio de 2,5mm de espessura;
- B** - Parte central em poliuretano injetado;
- C** - Aplicações de inox ou de vidros, conforme os modelos;
- D** - Perfis de alumínio "open termic 75".



Uniquement possible sur panneaux lisses ou fraisés avec / sans verre.

Épaisseur: 88mm

Ouverture maximale du mur: 2175 x 1005 mm.

COMPOSITION:

- A** - 2 feuilles d'aluminium de 2,5 mm d'épaisseur.
- B** - Intérieur en polyuréthane injecté.
- C** - Selon les différents modèles peuvent être avec l'application de vitrage ou Alulnox.
- D** - Profiles en aluminium "termic open 75".



Solo es posible en paneles lisos o fresados con / sin cristal
Espesor: 88mm

Apertura de pared máxima: 2175 x 1005 mm

COMPOSICIÓN:

- A** - 2 chapas de aluminio de 2,5 mm de espesor.
- B** - interior: poliuretano inyectado.
- C** - dependiendo de los diferentes modelos pueden ser con aplicación de vidrio o alulnox.
- D** - perfiles de aluminio "open termic 75"



Only possible on plain or milled panels with / without glass

Thickness: 88mm

Maximum wall opening: 2175 x 1005 mm

COMPOSITION:

- A** - 2 sheets of aluminium 2.5mm thickness.
- B** - Interior injected polyurethane.
- C** - Depending on the different models can be with glass application or Alulnox.
- D** - ALUMINIUM profiles "open termic 75"

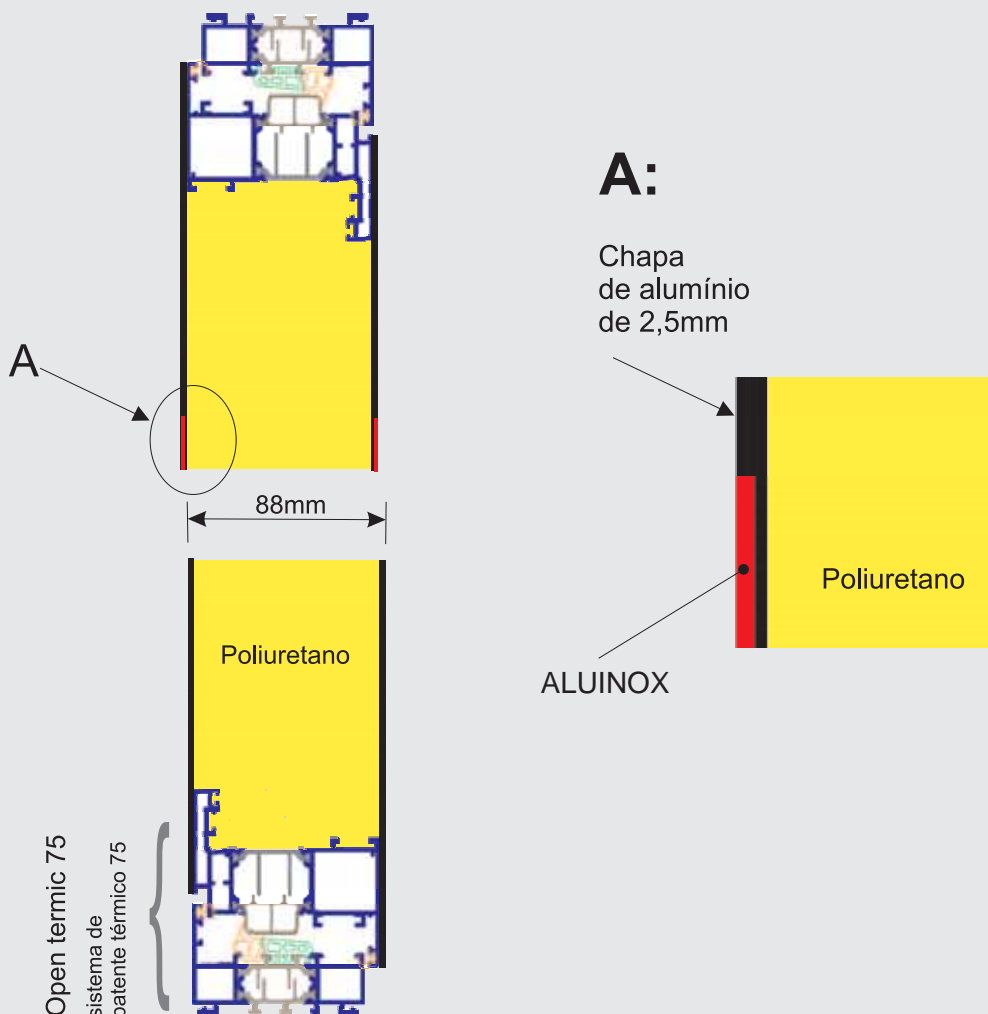

PUXADORES

PUXADORES // POIGNÉE DE PORTE // HANDLES

MODELOS // MODÈLES // MODELS

A - Ø 400mm X 30mm; B - 500mm X 40mm X 20mm; C - MEDIDA ÚNICA; D - 1200mm X 40mm X 20mm;

E - Ø 450mm X 20mm; F - 600mm X 30mm X 20mm;

G - Ø 1100mm X 30mm; H - 1100mm X 30mm X 20mm; I - 1100mm X 40mm X 20mm;

J - Ø 500mm X 40mm.

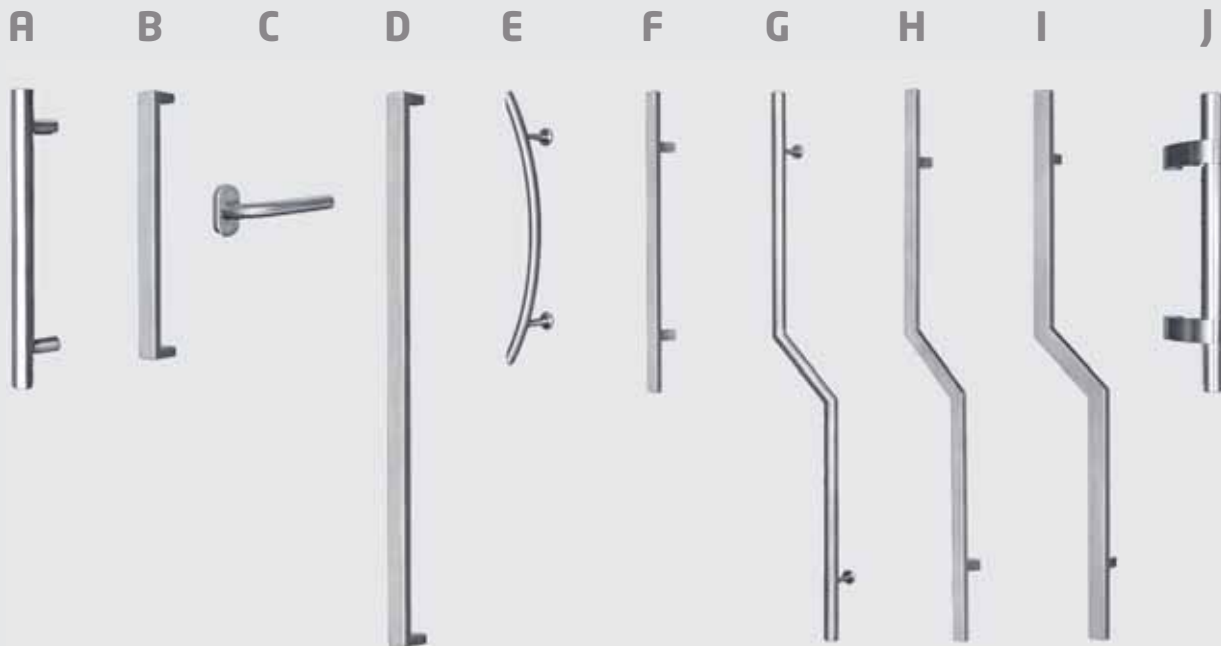

Para complementar as soluções oferecidas pelos diferentes tipos de painéis, apresentamos também os puxadores, em inox escovado.

Outros tamanhos: Sob orçamento.



Como complemento a las soluciones ofrecidas por los diferentes tipos de paneles, también presentamos las asas, en acero inoxidable cepillado.

Otras dimensiones: Bajo pedido.



Afin de compléter les solutions proposées par différents types de panneaux, nous présentons également les poignées, en acier inoxydable brossé.

Autres dimensions: Sur demande.



To complement the solutions offered by different types of panels, we also present the handles, brushed stainless steel.

Another sizes: Upon budget.

VIDROS E VITRAIS

VIDRIOS Y VITRALES / VITRAGES ET VITRAIL / GLASSES AND STAINED GLASS

MODELOS	COMPOSIÇÃO STANDARD:
PAINÉIS ESTAMPADOS	DELTA MATE + INCOLOR LISO INCOLOR LISO + VITRAL + INCOLOR LISO DELTA MATE + BARROTILO + INCOLOR LISO DELTA MATE + GRADE INTERIOR + INCOLOR LISO
PAINÉIS PERFIL	P126 + INCOLOR LISO INCOLOR LISO + VITRAL + INCOLOR LISO P126 + BARROTILO + INCOLOR LISO P126 + Gi + INCOLOR LISO
PAINÉIS NEW LINE PAINÉIS RETILINE PAINÉIS MAQUINADOS	FOSCO + FOSCO INCOLOR LISO + VITRAL + INCOLOR LISO

SOB ENCOMENDA PODE ALTERAR-SE A COMPOSIÇÃO DE QUALQUER MODELO

A SOLICITUD PUEDE CAMBIAR LA COMPOSICIÓN DE CUALQUIER MODELO

SUR DEMANDE PEUT MODIFIER LA COMPOSITION DE TOUT MODÈLE

ON REQUEST MAY CHANGE THE COMPOSITION OF ANY MODEL

**BARROTILOS: PODEM TER A COR O PAINEL
BARROTILOS SÓ DISPONIVEIS NUMA ÚNICA COR.**

RENGLÓN INTERNO DISPONIBLE SOLO EN UN COLOR.

CROISSILLON DISPONIBLE SEULEMENT EN UNE COULEUR.

INSIDER RUNG ONLY AVAILABLE IN ONE COLOR.

**VITRAIS / VITRALES / VITRAILES / STAINED GLASS:
EM FUNÇÃO DO MODELO E TAMBÉM PODEM SER
FEITOS POR ENCOMENDA**

SEGÚN EL MODELO Y TAMBÉN SE PUEDE HACER POR PEDIDO

CONFORMÉMENT AU MODÈLE ET PEUT ÉGALEMENT ÊTRE FAIT SUR COMMANDE

PURSUANT TO THE MODEL AND MAY ALSO BE MADE TO ORDER

TIPOS DE VIDROS E COMPOSIÇÕES DISPONÍVEIS

TIPOS DE VIDRIOS Y COMPOSICIONES DISPONIBLES / TYPES DE VITRAGES ET COMPOSITIONS DISPONIBLES / TYPES OF GLASSES AND AVAILABLE COMPOSITIONS



FOSCADO



CATEDRAL



DELTA MATE



ESCARCHA



ESPIGA



FOSCO



GAUDI



P126



PICKLES



BARROTILO



Gi



BARROTILO
BRANCO

"ALMOFADAS"

"ALMOHADILLAS" / "COUSSINS" / CUSHIONS"



Chapas de Alumínio complementares simples ou injetadas

SIMPLES

Solução económica, para utilização em espaços onde não existe grande exigência de isolamento térmico e acústico;

INJECTADAS

Solução que permite uma elevada melhoria no isolamento térmico e acústico do espaço onde vão ser aplicadas.

SÉRIE DE CORRER

Com esta referência EXCLUSIVA, colocamos no mercado almofadas em que o relevo é rebaixado e nivelado pela superfície exterior, originando um produto que pode ser utilizado em aplicações onde até agora o relevo das almofadas era uma limitação

ACABAMENTOS

Disponível em bruto e todos os tipos de acabamentos oferecidos para painéis.



Plaques Aluminium emboutis complémentaires simple ou injectées.

SIMPLES

Solution économique, utilisation sans exigences d'isolation thermique ou acoustique élevées.

INJECTÉES

Solution qui permet une grande amélioration de l'isolation thermique et acoustique de l'espace où elles seront appliqués.

GLISSEMENT

Avec cette référence EXCLUSIVE, nous mettons sur le marché des "coussins" dans lesquels le relief est abaissé et nivelé par la surface extérieure, originant un produit pouvant être utilisé dans des applications où jusqu'à présent le relief des "coussins" était une limitation.

FINITIONS

Disponibile en brut et dans toutes les finitions proposés pour les panneaux.



Chapas Alumínio impresas complementarias simples o inyectadas.

SIMPLES

Solución económica, utilización sin requisitos de gran exigencia de aislamiento térmico o acústico.

INYECTADAS

Solución que permite una elevada mejora en el aislamiento térmico y acústico del espacio donde se aplicarán.

SERIES CORREDIZAS

Con esta referencia EXCLUSIVA, ponemos en el mercado "almohadillas" en los que el relieve es rebajado y nivelado por la superficie exterior, originando un producto que puede ser utilizado en aplicaciones donde hasta ahora el relieve de las "almohadillas" era una limitación.

ACABADOS

Disponible en bruto y todo tipo de acabados ofrecidos para paneles.



Complementary printed Aluminium plate's simple or injected.

SIMPLE

Economic solution, use without high thermal or acoustic insulation requirements.

INJECTED

Solution that allows a high improvement in thermal and acoustic insulation of the space where they will be applied.

SLIDING

With this reference EXCLUSIVE, we put on the market "cushions" in which the relief is lowered and levelled by the outer surface, originating a product that can be used in applications where until now the relief of the "cushions" was a limitation.

FINISHES

Available in rough and in all finishes offered for panels.





Modelo m



Modelo p

MEDIDA	RELEVO	MEDIDA	RELEVO	MEDIDA	RELEVO	MEDIDA	RELEVO	MEDIDA	RELEVO
26 x 26m	11.5 x 11.5	50 x 50m	32 x 32	26 x 33	13 x 18	40 x 40	25 x 25	60 x 60	42 x 42
26 x 33m	11.5 x 19	50 x 60m	32 x 40	26 x 40	13 x 25	40 x 46	25 x 31	60 x 66	42 x 48
26 x 40m	11.5 x 20	50 x 70m	32 x 50	26 x 46	13 x 31	40 x 50	25 x 31	60 x 70	42 x 48
26 x 50m	11.5 x 30	50 x 80m	32 x 60	26 x 50	13 x 31	40 x 57	25 x 42	60 x 80	42 x 58
26 x 60m	11.5 x 40	50 x 90m	32 x 70	26 x 57	13 x 42	40 x 60	25 x 42	60 x 90	42 x 58
26 x 70m	11.5 x 50	50 x 100m	32 x 70	26 x 60	13 x 42	40 x 66	25 x 48	60 x 105	42 x 84
26 x 80m	11.5 x 60			26 x 68	13 x 48	40 x 70	25 x 48	60 x 120	42 x 84
26 x 90m	11.5 x 60	60 x 60m	40 x 40	26 x 70	13 x 48	40 x 80	25 x 58		
26 x 100m	11.5 x 60	60 x 70m	40 x 50	26 x 80	13 x 58	40 x 92	25 x 72	66 x 66	48 x 48
		60 x 80m	40 x 60	26 x 90	13 x 58	40 x 100	25 x 72	66 x 105	48 x 84
		60 x 90m	40 x 60	26 x 100	13 x 58	40 x 110	25 x 72	68 x 80	48 x 58
		60 x 100m	40 x 60						
33 x 33m	19 x 19	70 x 80m	50 x 60	33 x 33	18 x 18	47 X 47	31 X 31	70 x 70	48 x 48
33 x 40m	19 x 25			33 x 40	18 x 25	47 X 58	31 X 42	70 x 90	48 x 58
33 x 50m	19 x 32			33 x 46	18 x 31	47 X 65	31 X 48	70 x 120	48 x 84
33 x 60m	19 x 40	75 x 70m	50 x 50	33 x 50	18 x 31	47 X 80	31 X 58		
33 x 70m	19 x 50	75 x 80m	50 x 60	33 x 57	18 x 42				
33 x 80m	19 x 60	75 x 90m	50 x 60	33 x 60	18 x 42	50 x 50	31 x 31	72 x 72	48 x 48
33 x 90m	19 x 70	75 x 100m	50 x 60	33 x 63	18 x 48	50 x 60	31 x 42		
33 x 100m	19 x 70			33 x 70	18 x 48	50 x 70	31 x 48	80 x 80	58 x 58
33 x 120m	19 x 70	80 x 80m	60 x 60	33 x 80	18 x 58	50 x 80	31 x 58	80 x 90	58 x 69,5
		80 x 90m	60 x 70	33 x 92	18 x 71,5	50 x 90	31 x 58	80 x 105	58 x 84
40 x 40m	25 x 25	80 x 110m	60 x 70	33 x 100	18 x 72	50 x 100	31 x 58	80 x 120	58 x 98
40 x 50m	25 x 32			33 x 110	18 x 72				
40 x 60m	25 x 40								
40 x 70m	25 x 50	90 x 90m	60 x 60					90 x 90	58 x 58
40 x 80m	25 x 60	90 x 110m	60 x 70					90 x 110	58 x 84
40 x 90m	25 x 70							90 x 125	58 x 98
40 x 100m	25 x 70								
40 x 110m	25 x 70								
40 x 120m	25 x 70								



Detalhe de funcionamento



MODELO SC

MEDIDA	RELEVO	MEDIDA	RELEVO	MEDIDA	RELEVO
33x33	19x19	40x50	19x32		
33x50	19x30	40x60	25x40	70x75	50x50
33x60	19x40	40x70	25x50		
33x70	19x50	40x80	25x60	80x80	50x50
33x80	19x60	40x90	25x70	80x90	50x50
33x90	19x70	40x100	25x70		
33x100	19x70			90x110	50x50
		50x60	32x40		
		50x70	32x50		
		50x80	32x60		

GARANTIA LIMITADA



GARANTIA LIMITADA:

Os produtos BRAMOLDE têm a garantia de 2 anos, contra eventuais defeitos de fabrico.

Após verificação e validação das anomalias, a BRAMOLDE procederá à substituição dos componentes com defeito de fabrico, sem obrigação de qualquer outro tipo de indemnização.

Todos os casos omissos serão objeto de estudo por parte da BRAMOLDE, que atuará em conformidade com a situação.

ESTÃO EXCLUÍDOS DA GARANTIA BRAMOLDE:

Defeitos originados no transporte.

Defeitos originados na instalação, montagem e utilização.

Defeitos inerentes à incorreta manutenção do produto, como por exemplo a utilização de produtos de limpeza inadequados (solventes, abrasivos, etc..).

Defeitos de lacagem da zona de encaixe, até 25 mm, contados a partir dos lados, em toda a volta do painel.

Serviços externos (Lacados madeira, anodização, etc.) executados em empresas escolhidas pelo cliente (nestes casos a responsabilidade integral é do cliente).

Lacagem de chapas com pó fornecido pelo cliente (neste caso o Cliente assume toda a responsabilidade acerca da qualidade do resultado final, sendo debitados os respetivos valores de chapas e lacagem. Em caso de necessidade de repetição do processo, serão também debitados todos os custos inerentes).

Reparação de painéis a pedido de clientes (nestes casos a responsabilidade é do cliente, seja no resultado final ou nos custos associados).

Defeitos originado pela montagem (de salientar que os painéis com acabamentos de cores escuras devem ser cortados com maior folga do que os painéis de cores claras, de forma a minimizar o empenho nos mesmos, provocado pela dilatação que sofrem quando expostos à luz solar).

NOTAS IMPORTANTES:

A BRAMOLDE não fará a substituição de painéis após estes terem sido sujeitos a operações de corte ou ter sido alterada qualquer outra característica.

Na falta de indicação de espessura na encomenda, será assumido o valor de 20mm, podendo ser de 24mm no caso de painéis com vidro.

No caso de autorização de substituição de painéis, a mesma só pode ser feita desde que o artigo se encontre nas mesmas condições em que foi vendido: embalado de forma correta na embalagem original e acompanhados de todos os acessórios (caso fornecidos).

Devido ao processo de fotocomposição e impressão dos catálogos, as cores, tonalidades e materiais como de igual modo a visualização em meios digitais (telemóveis, computadores, etc..) poderão não representar corretamente as características finais do produto, aconselhando-se a consulta de modelos e/ou amostras.

Devido às características específicas dos processos de anodização por amostra, as cores, tonalidades e materiais obtidos poderão não apresentar os resultados pretendidos, sendo os resultados obtidos, ou a obter, da inteira responsabilidade do cliente que solicita o serviço.

As encomendas de cores referentes a armazéns de alumínio devem ser feitas indicando a Referência exata e o Fabricante do pó, assumindo o cliente todas as responsabilidades na cor obtida quando o fornecimento dos dados for incompletos.

Todos os painéis BRAMOLDE possuem no seu interior a data de fabrico.

Reservamo-nos o direito de alterar ou retirar, sem aviso prévio, qualquer característica do/ou produto BRAMOLDE.

DIREITO APLICÁVEL E COMPETÊNCIA JURÍDICA

Todas as Leis são regidas pelo Direito do Estado Português.

Em caso de litígio, independentemente da sua natureza, relativo a venda, cumprimento de prazos, execução do pedido ou interpretação, o Tribunal competente é o da Comarca de Braga.

GARANTÍA LIMITADA



Los productos BRAMOLDE tienen una garantía de 2 años contra posibles defectos de fabricación.

Después de la verificación y validación de las anomalías, BRAMOLDE reemplazará los componentes defectuosos sin obligación de ninguna otra compensación.

Todos los casos omitidos serán objeto de estudio por parte de BRAMOLDE, que actuará de acuerdo con la situación.

EXCLUIDOS DE LA GARANTÍA DE BRAMOLDE:

Defectos de transporte.

Defectos causados por la instalación, montaje y uso.

Defectos inherentes al mantenimiento inadecuado del producto, como el uso de agentes de limpieza inadecuados (solventes, abrasivos, etc.).

Defectos de lacado en el área del asiento, hasta 25 mm, contados desde los lados, alrededor del panel.

Servicios externos (lacado de madera, anodizado, etc.) realizados en empresas elegidas por el cliente (en estos casos la responsabilidad total es del cliente).

Lacado de chapas con polvo suministrado por el cliente (en estos casos el cliente asume toda la responsabilidad acerca de la calidad del resultado final, siendo debitados los valores de chapa y lacado). En caso de necesidad de repetición del proceso, se cargarán todos los costes inherentes.

Reparación de paneles a pedido de clientes (en estos casos es responsabilidad de los clientes, sea en el resultado final o en los costos asociados).

Los paneles oscuros deben ser cortados con mayor holgura que los claros, con el fin de evitar a deformación de la misma, causada por la mayor dilatación que sufren cuando se expone a la luz solar.

NOTAS IMPORTANTES:

BRAMOLDE no reemplazará los paneles después de que se hayan sido sometidos a operaciones de corte se han modificado o cualquier otra característica.

En ausencia de una indicación de grosor al realizar el pedido, se asumirá el valor de 20 mm, y puede ser de 24 mm en el caso de paneles con vidrio.

En el caso de la autorización para reemplazar paneles, esto solo se puede hacer siempre que el artículo esté en las mismas condiciones en que se vendió: correctamente embalado en el embalaje original y acompañado de todos los accesorios (si se proporcionan).

Debido al proceso de fotocomposición e impresión de los catálogos, los colores, tonos y materiales, así como la visualización en medios digitales (teléfonos móviles, ordenadores, etc.) pueden no representar correctamente las características finales del producto, aconsejando la consulta modelos y / o muestras.

Debido a las características específicas de los procesos de anodización de la muestra, los colores, tonos y materiales obtenidos pueden no presentar los resultados deseados, los resultados obtenidos o por obtener, son responsabilidad exclusiva del cliente que solicita el servicio.

Los pedidos de color para los almacenes de aluminio deben hacerse indicando la referencia exacta y el fabricante del polvo, enfatizamos que al no proporcionar datos completos, el cliente asume toda la responsabilidad por el color obtenido.

Todos los paneles BRAMOLDE tienen la fecha de fabricación en el interior.

Nos reservamos el derecho de cambiar o retirar sin previo aviso cualquier característica del producto BRAMOLDE.

LEY APLICABLE Y COMPETENCIA LEGAL

Todas las leyes se rigen por la ley del Estado portugués.

En caso de litigio, cualquiera que sea su naturaleza, en relación con la venta, el cumplimiento de los plazos, la ejecución de la solicitud o la interpretación, el tribunal competente será el de Braga



Les produits BRAMOLDE sont garantis 2 ans contre d'éventuels défauts de fabrication.

Après vérification et validation des anomalies, BRAMOLDE remplacera les composants défectueux sans obligation d'aucune autre compensation.

Tous les cas omis feront l'objet d'une étude par BRAMOLDE, qui agira en fonction de la situation.

EXCLU DE LA GARANTIE BRAMOLDE:

Défauts de transport.

Défauts causés par l'installation, l'assemblage et l'utilisation.

Défauts inhérents à un mauvais entretien du produit, tels que l'utilisation d'agents de nettoyage inappropriés (solvants, abrasifs, etc.).

Défauts de laquage dans la zone d'assise, jusqu'à 25 mm, comptés sur les côtés, tout autour du panneau.

Prestations externes (laquage bois, anodisation, etc.) réalisées dans des entreprises choisies par le client (dans ces cas, l'entière responsabilité incombe au client).

Revêtement en poudre fourni par le client, dans ces cas, le client assume toute la responsabilité de la qualité du résultat final, les valeurs respectives des plaques et du laquage étant débitées.

Remarque: En cas de nécessité de répétition du processus, tous les coûts inhérents seront facturés.

Les panneaux sombres doivent être coupés avec plus large de clair, afin d'éviter de déformer le même, causé par la souffrance plus d'expansion lorsqu'il est exposé à la lumière du soleil.

Réparation de panneaux à la demande du client (dans ces cas, le client est responsable, soit du résultat final, soit des coûts associés).

Les défauts causés par l'installation (s'il vous plaît noter que les panneaux avec des finitions de couleurs foncée doivent être coupés plus mou que les panneaux de couleur clair, afin de minimiser l'effort en eux, causé par la souffrance de dilatation lorsqu'il est exposé à la lumière du soleil).

NOTES IMPORTANTES:

BRAMOLDE ne remplacera pas les panneaux après avoir été coupés ou autrement modifiés.

En l'absence d'indication d'épaisseur lors de la commande, la valeur de 20 mm sera retenue, et pourra être de 24 mm dans le cas de panneaux en verre.

En cas d'autorisation de remplacement de panneaux, cela ne peut se faire que si l'article est dans le même état qu'il a été vendu: correctement emballé dans son emballage d'origine et accompagné de tous les accessoires (si fournis).

En raison du processus de photocomposition et d'impression des catalogues, les couleurs, les nuances et les matériaux ainsi que la visualisation dans les médias numériques (téléphones mobiles, ordinateurs, etc.) peuvent ne pas représenter correctement les caractéristiques finales du produit, conseiller à la consultation des modèles et / ou échantillons.

En raison des caractéristiques spécifiques des processus d'anodisation des échantillons, les couleurs, les nuances et les matériaux obtenus peuvent ne pas présenter les résultats souhaités et les résultats obtenus ou à obtenir sont de la seule responsabilité du client qui demande le service.

Les commandes pour les couleurs liées aux entrepôts d'aluminium doivent être effectuées en indiquant la référence exacte et le fabricant de poudre, nous soulignons que l'absence de données complètes, le client assume l'entière responsabilité de la couleur obtenue.

Tous les panneaux BRAMOLDE ont la date de fabrication à l'intérieur.

Nous nous réservons le droit de modifier ou de supprimer, sans préavis, toute caractéristique / ou d'un produit BRAMOLDE.

LOI APPLICABLE ET COMPÉTENCE JURIDIQUE

Toutes les lois sont régies par la loi de l'État portugais.

En cas de litige, quelle que soit sa nature, concernant la vente, le respect des délais, l'exécution de la demande ou l'interprétation, le tribunal compétent sera celui de Braga.

LIMITED WARRANTY



BRAMOLDE products are warranted for 2 years against possible manufacturing defects.

After verification and validation of the anomalies, BRAMOLDE will replace the defective components without obligation of any other compensation.

All omitted cases will be the object of study by BRAMOLDE, which will act in accordance with the situation.

EXCLUDED FROM BRAMOLDE WARRANTY:

Transport defects.

Defects caused by installation, assembly and use.

Defects inherent in improper product maintenance, such as the use of improper cleaning agents (solvents, abrasives, etc.).

Lacquering defects in the seating area, up to 25 mm, counted from the sides, all around the panel.

External services (wood Lacquered, anodizing, etc.) performed in companies chosen by the customer (in these cases is the full responsibility of the customer).

Powder coating supplied by customer:

In these cases the customer assumes all responsibility about the quality of the final result. The values of plates and lacquering will be charged.

Note: In case of need of repetition of the process, all inherent costs will be charged again.

Dark panels should be cut slacker than clearings, so as to avoid warping in them, caused by the greater dilation they suffer when exposed to sunlight.

Repair of panels on customer request (in these cases the customer is responsible for either the end result or the associated costs).

Defects caused by the installation (please note that panels with dark color finishes should be cut more slack than light color panels, in order to minimize the effort in them, caused by dilation suffering when exposed to sunlight).

IMPORTANT NOTES:

BRAMOLDE will not replace panels after they have been cut or otherwise changed.

In the absence of an indication of thickness when ordering, the value of 20mm will be assumed, and may be 24mm in the case of panels with glass.

In the case of authorization to replace panels, this can only be done as long as the article is in the same condition as it was sold: correctly packaged in the original packaging and accompanied by all accessories (if provided).

Due to the photocomposition and printing process of the catalogs, the colors, shades and materials as well as the visualization in digital media (mobile phones, computers, etc...) may not represent correctly the final characteristics of the product, advising to consultation models and / or samples.

Due to the specific characteristics of the sample anodizing processes, the colours, shades and materials obtained may not present the desired results, being the results obtained, or to be obtained, the sole responsibility of the customer requesting the service.

Color orders for aluminum warehouses should be made indicating the exact Reference and the Powder Manufacturer, we emphasize that by not providing complete data, the customer assumes all responsibility for the color obtained.

All BRAMOLDE panels have the date of manufacture inside.

We reserve the right to change or remove without prior notice any feature / or BRAMOLDE product.

APPLICABLE LAW AND LEGAL COMPETENCE

All Laws are governed by Portuguese State Law.

In the event of a dispute, whatever its nature, concerning the sale, the fulfilment of time-limits, the execution of the request or the interpretation, the competent court shall be that of Braga County.



A Bramolde foi fundada em 1988, em Braga, com o principal objetivo de fabricar moldes, cunhos, cortantes e similares, para a indústria metalomecânica e fundição de alumínio. Desde aí, e até aos dias de hoje, a evolução e exigência do mercado, a par do desejo constante de inovação e superação, traduzem-se no crescimento sustentado da nossa empresa, fruto de uma estratégia de olhos postos no presente e no futuro.



Bramolde fue fundada en 1988, en Braga, con el principal objetivo de fabricar moldes y utillajes, para la industria metalmeccánica y fundición de aluminio. Desde ese momento, y hasta nuestros días, la evolución y exigencia del mercado, a la par con el deseo constante de innovación y superación, se traducen en el crecimiento sostenible de nuestra empresa, fruto de una estrategia orientada hacia el presente y hacia el futuro.



Bramolde a été fondée en 1988 à Braga, avec l'objectif principal pour la fabrication de moules, outils de coupe et similaires, pour l'industrie du métal et de fonderie d'aluminium. Depuis lors, et jusqu'à nos jours, l'évolution et la demande du marché, à côté du désir constant d'innovation et de surmonter, reflété dans la croissance soutenue de notre société, le résultat d'une stratégie mise yeux dans le présent et dans le futur.



Bramolde was founded in 1988 in Braga, with the main objective to manufacture moulds, dies, cutters and similar, for the metal industry and aluminium foundry. Since then, and until the present day, developments and market demand, hand and hand with the constant desire for innovation and improvement, are reflected in the sustained growth of our company, result of a strategy with eyes in the present and in the future.

Descarregue a nossa APP
Download our APP



bramolde.pt

Rua S. Vicente de Paulo, 41
Parque Industrial de Adaúfe
4710-593 BRAGA · PORTUGAL
comercial@bramolde.pt
T +351 253 628 974